

---

# THE VIRGINIA REGISTER INFORMATION PAGE

---

**THE VIRGINIA REGISTER** is an official state publication issued every other week throughout the year. Indexes are published quarterly, and the last index of the year is cumulative. **THE VIRGINIA REGISTER** has several functions. The new and amended sections of regulations, both as proposed and as finally adopted, are required by law to be published in **THE VIRGINIA REGISTER OF REGULATIONS**. In addition, **THE VIRGINIA REGISTER** is a source of other information about state government, including all emergency regulations and executive orders issued by the Governor, the Virginia Tax Bulletin issued periodically by the Department of Taxation, and notices of public hearings and open meetings of state agencies.

## ADOPTION, AMENDMENT, AND REPEAL OF REGULATIONS

An agency wishing to adopt, amend, or repeal regulations must first publish in the *Virginia Register* a notice of intended regulatory action; a basis, purpose, substance and issues statement; an economic impact analysis prepared by the Department of Planning and Budget; the agency's response to the economic impact analysis; a summary; a notice giving the public an opportunity to comment on the proposal; and the text of the proposed regulation.

Following publication of the proposal in the *Virginia Register*, the promulgating agency receives public comments for a minimum of 60 days. The Governor reviews the proposed regulation to determine if it is necessary to protect the public health, safety and welfare, and if it is clearly written and easily understandable. If the Governor chooses to comment on the proposed regulation, his comments must be transmitted to the agency and the Registrar no later than 15 days following the completion of the 60-day public comment period. The Governor's comments, if any, will be published in the *Virginia Register*. Not less than 15 days following the completion of the 60-day public comment period, the agency may adopt the proposed regulation.

The appropriate standing committee of each branch of the General Assembly may meet during the promulgation or final adoption process and file an objection with the Registrar and the promulgating agency. The objection will be published in the *Virginia Register*. Within 21 days after receipt by the agency of a legislative objection, the agency shall file a response with the Registrar, the objecting legislative committee, and the Governor.

When final action is taken, the agency again publishes the text of the regulation as adopted, highlighting all changes made to the proposed regulation and explaining any substantial changes made since publication of the proposal. A 30-day final adoption period begins upon final publication in the *Virginia Register*.

The Governor may review the final regulation during this time and, if he objects, forward his objection to the Registrar and the agency. In addition to or in lieu of filing a formal objection, the Governor may suspend the effective date of a portion or all of a regulation until the end of the next regular General Assembly session by issuing a directive signed by a majority of the members of the appropriate standing committees and the Governor. The Governor's objection or suspension of the regulation, or both, will be published in the *Virginia Register*. If the Governor finds that changes made to the proposed regulation have substantial impact, he may require the agency to provide an additional 30-day public comment period on the changes. Notice of the additional public comment period required by the Governor will be published in the *Virginia Register*.

The agency shall suspend the regulatory process for 30 days when it receives requests from 25 or more individuals to solicit additional public comment, unless the agency determines that the changes have minor or inconsequential impact.

A regulation becomes effective at the conclusion of the 30-day final adoption period, or at any other later date specified by the promulgating agency, unless (i) a legislative objection has been filed, in which event the regulation, unless withdrawn, becomes effective on the date specified, which shall be after the expiration of the 21-day extension

period; (ii) the Governor exercises his authority to require the agency to provide for additional public comment, in which event the regulation, unless withdrawn, becomes effective on the date specified, which shall be after the expiration of the period for which the Governor has provided for additional public comment; (iii) the Governor and the General Assembly exercise their authority to suspend the effective date of a regulation until the end of the next regular legislative session; or (iv) the agency suspends the regulatory process, in which event the regulation, unless withdrawn, becomes effective on the date specified, which shall be after the expiration of the 30-day public comment period.

Proposed regulatory action may be withdrawn by the promulgating agency at any time before the regulation becomes final.

## EMERGENCY REGULATIONS

If an agency demonstrates that (i) there is an immediate threat to the public's health or safety; or (ii) Virginia statutory law, the appropriation act, federal law, or federal regulation requires a regulation to take effect no later than (a) 280 days from the enactment in the case of Virginia or federal law or the appropriation act, or (b) 280 days from the effective date of a federal regulation, it then requests the Governor's approval to adopt an emergency regulation. The emergency regulation becomes operative upon its adoption and filing with the Registrar of Regulations, unless a later date is specified. Emergency regulations are limited to addressing specifically defined situations and may not exceed 12 months in duration. Emergency regulations are published as soon as possible in the *Register*.

During the time the emergency status is in effect, the agency may proceed with the adoption of permanent regulations through the usual procedures. To begin promulgating the replacement regulation, the agency must (i) file the Notice of Intended Regulatory Action with the Registrar within 60 days of the effective date of the emergency regulation; and (ii) file the proposed regulation with the Registrar within 180 days of the effective date of the emergency regulation. If the agency chooses not to adopt the regulations, the emergency status ends when the prescribed time limit expires.

## STATEMENT

The foregoing constitutes a generalized statement of the procedures to be followed. For specific statutory language, it is suggested that Article 2 (§ 9-6.14:7.1 et seq.) of Chapter 1.1:1 of the Code of Virginia be examined carefully.

## CITATION TO THE VIRGINIA REGISTER

The *Virginia Register* is cited by volume, issue, page number, and date. **12:8 VA.R. 1096-1106 January 8, 1996**, refers to Volume 12, Issue 8, pages 1096 through 1106 of the *Virginia Register* issued on January 8, 1996.

**"THE VIRGINIA REGISTER OF REGULATIONS"** (USPS-001831) is published bi-weekly, with quarterly cumulative indices published in January, April, July and October, for \$100 per year by the Virginia Code Commission, General Assembly Building, Capitol Square, Richmond, Virginia 23219. Telephone (804) 786-3591. Periodical Postage Rates Paid at Richmond, Virginia. **POSTMASTER:** Send address changes to **THE VIRGINIA REGISTER OF REGULATIONS, 910 CAPITOL STREET, 2ND FLOOR, RICHMOND, VIRGINIA 23219.**

*The Virginia Register of Regulations* is published pursuant to Article 7 (§ 9-6.14:22 et seq.) of Chapter 1.1:1 of Title 9 of the Code of Virginia. Individual copies, if available, may be purchased for \$4.00 each from the Registrar of Regulations.

Members of the Virginia Code Commission: **Joseph V. Gartlan, Jr.**, Chairman; **W. Tayloe Murphy, Jr.**, Vice Chairman; **Robert L. Calhoun**; **Russell M. Carneal**; **Bernard S. Cohen**; **Jay W. DeBoer**; **Frank S. Ferguson**; **E. M. Miller, Jr.**; **Jackson E. Reasor, Jr.**; **James B. Wilkinson.**

Staff of the Virginia Register: **E. M. Miller, Jr.**, Acting Registrar of Regulations; **Jane D. Chaffin**, Deputy Registrar of Regulations.

---

---

# PUBLICATION DEADLINES AND SCHEDULES

---

This schedule is available on the *Register's* Internet home page (<http://legis.state.va.us/codecomm/register/regindex.htm>).

---

## June 1998 through March 1999

<u>Volume:Issue</u>	<u>Material Submitted By Noon*</u>	<u>Will Be Published On</u>
14:20	June 3, 1998	June 22, 1998
<b>INDEX 3 - Volume 14</b>		<b>July 1998</b>
14:21	June 17, 1998	July 6, 1998
14:22	July 1, 1998	July 20, 1998
14:23	July 15, 1998	August 3, 1998
14:24	July 29, 1998	August 17, 1998
14:25	August 12, 1998	August 31, 1998
14:26	August 26, 1998	September 14, 1998
<b>FINAL INDEX - Volume 14</b>		<b>October 1998</b>
15:1	September 9, 1998	September 28, 1998
15:2	September 23, 1998	October 12, 1998
15:3	October 7, 1998	October 26, 1998
15:4	October 21, 1998	November 9, 1998
15:5	November 4, 1998	November 23, 1998
15:6	November 17, 1998 ( <b>Tuesday</b> )	December 7, 1998
15:7	December 2, 1998	December 21, 1998
<b>INDEX 1 - Volume 15</b>		<b>January 1999</b>
15:8	December 15, 1998 ( <b>Tuesday</b> )	January 4, 1999
15:9	December 29, 1998 ( <b>Tuesday</b> )	January 18, 1999
15:10	January 13, 1999	February 1, 1999
15:11	January 27, 1999	February 15, 1999
15:12	February 10, 1999	March 1, 1999
15:13	February 24, 1999	March 15, 1999
15:14	March 10, 1999	March 29, 1999
<b>INDEX 2 - Volume 15</b>		<b>April 1999</b>

\*Filing deadlines are Wednesdays unless otherwise specified.

---

# TABLE OF CONTENTS

---

Tables of contents for issues in Volumes 13 and 14 are available on the *Register's* Internet home page  
(<http://legis.state.va.us/codecomm/register/regindex.htm>).

---

## CUMULATIVE TABLE OF VIRGINIA ADMINISTRATIVE CODE SECTIONS ADOPTED, AMENDED, OR REPEALED

Title 2. Agriculture .....	2707
Title 4. Conservation and Natural Resources .....	2707
Title 6. Criminal Justice and Corrections .....	2712
Title 9. Environment .....	2712
Title 10. Finance and Financial Institutions .....	2713
Title 11. Gaming .....	2714
Title 12. Health .....	2714
Title 13. Housing .....	2715
Title 16. Labor and Employment .....	2715
Title 18. Professional and Occupational Licensing .....	2715
Title 19. Public Safety .....	2716
Title 20. Public Utilities and Telecommunications .....	2716
Title 21. Securities and Retail Franchising .....	2716
Title 24. Transportation .....	2716

## PUBLIC COMMENT PERIODS - PROPOSED REGULATIONS

### TITLE 19. PUBLIC SAFETY

Department of State Police .....	2717
----------------------------------	------

## PROPOSED REGULATIONS

### TITLE 19. PUBLIC SAFETY.

#### DEPARTMENT OF STATE POLICE

Motor Vehicle Safety Inspection Rules and Regulations (amending 19 VAC 30-70-5, 19 VAC 30-70-7, 19 VAC 30-70- 10, 19 VAC 30-70-50, 19 VAC 30-70-70, 19 VAC 30-70-80, 19 VAC 30-70-90, 19 VAC 30-70-100, 19 VAC 30-70-140, 19 VAC 30-70-160, 19 VAC 30-70-180, 19 VAC 30-70-200, 19 VAC 30-70-440, 19 VAC 30-70-450, 19 VAC 30-70-460, 19 VAC 30-70-470, 19 VAC 30-70-480, 19 VAC 30-70-490, 19 VAC 30-70-500, 19 VAC 30-70-550, 19 VAC 30-70-570, 19 VAC 30-70-580 and 19 VAC 30-70-680). .....	2718
---	------

## FINAL REGULATIONS

### TITLE 8. EDUCATION

#### STATE BOARD OF EDUCATION

Regulations Governing the Licensure of School Personnel  
(repealing 8 VAC 20-20-750, 8 VAC 20-20-770, 8 VAC  
20-20-780 and 8 VAC 20-20-790)..... 2754

Licensure Regulations for School Personnel (adding 8 VAC  
20-21-425, 8 VAC 20-21-430, 8 VAC 20-21-435, 8 VAC  
20-21-440, and 8 VAC 20-21-445)..... 2754

### TITLE 16. LABOR AND EMPLOYMENT

#### GOVERNOR'S EMPLOYMENT AND TRAINING DEPARTMENT

JTPA (Job Training Partnership Act) Requirements  
(amending 16 VAC 10-20-10, 16 VAC 10-20-20, 16 VAC 10-  
20-30, 16 VAC 10-20-40, 16 VAC 10-20-80, 16 VAC 10-20-  
110, 16 VAC 10-20-140, 16 VAC 10-20-150, 16 VAC 10-20-  
160, 16 VAC 10-20-170, 16 VAC 10-20-190, 16 VAC 10-20-  
200, 16 VAC 10-20-240, 16 VAC 10-20-280, 16 VAC 10-20-  
300; adding 16 VAC 10-20-275; repealing 16 VAC 10-20-50,  
16 VAC 10-20-60, 16 VAC 10-20-70, 16 VAC 10-20-90,  
16 VAC 10-20-100, 16 VAC 10-20-180, 16 VAC 10-20-210,  
16 VAC 10-20-220, 16 VAC 10-20-230, 16 VAC 10-20-250,  
16 VAC 10-20-260, 16 VAC 10-20-270, 16 VAC 10-20-290,  
and 16 VAC 10-20-310 through 16 VAC 10-20-460). .....

### TITLE 18. PROFESSIONAL AND OCCUPATIONAL LICENSING

#### REAL ESTATE BOARD

Virginia Real Estate Board Licensing Regulations (amending  
18 VAC 135-20-10, 18 VAC 135-20-20, 18 VAC 135-20-30,  
18 VAC 135-20-40, 18 VAC 135-20-50, 18 VAC 135-20-60,  
18 VAC 135-20-80, 18 VAC 135-20-90, 18 VAC 135-20-100,  
18 VAC 135-20-110, 18 VAC 135-20-120, 18 VAC 135-20-  
150, 18 VAC 135-20-160, 18 VAC 135-20-170, 18 VAC 135-  
20-180, 18 VAC 135-20-190, 18 VAC 135-20-200, 18 VAC  
135-20-210, 18 VAC 135-20-220, 18 VAC 135-20-240,  
18 VAC 135-20-250, 18 VAC 135-20-260, 18 VAC 135-20-  
270, 18 VAC 135-20-280, 18 VAC 135-20-290, 18 VAC 135-  
20-300, 18 VAC 135-20-310, 18 VAC 135-20-320, 18 VAC  
135-20-350, 18 VAC 135-20-360, 18 VAC 135-20-370,  
18 VAC 135-20-380, 18 VAC 135-20-390, 18 VAC 135-20-  
400 and 18 VAC 135-20-410; adding 18 VAC 135-20-45;  
repealing 18 VAC 135-20-420, 18 VAC 135-20-430, and  
18 VAC 135-20-440). .....

---

# Table of Contents

---

## FORMS

### DEPARTMENT OF MINES, MINERALS AND ENERGY

Coal Surface Mining Reclamation Regulations. (4 VAC 25-130-10 et seq.)..... [2787](#)

## GOVERNOR

### EXECUTIVE ORDER

Creating the Office of the Secretary of Technology and Establishing a Blue Ribbon Commission, the Governor's Commission on Information Technology. (9-98) ..... [2795](#)

## SCHEDULES FOR COMPREHENSIVE REVIEW OF REGULATIONS

Department of Social Services ..... [2797](#)

## GENERAL NOTICES/ERRATA

### STATE CORPORATION COMMISSION

#### ORDER

In the matter of revising the telephone relay service surcharge pursuant to Article 5, Chapter 15, Title 56 of the Code of Virginia ..... [2798](#)

### VIRGINIA CODE COMMISSION

Notice to Subscribers ..... [2798](#)

Notice to State Agencies ..... [2799](#)

Forms for Filing Material for Publication in *The Virginia Register of Regulations* ..... [2799](#)

## CALENDAR OF EVENTS

### EXECUTIVE

Open Meetings and Public Hearings..... [2800](#)

### INDEPENDENT

Open Meetings and Public Hearings..... [2813](#)

### LEGISLATIVE

Open Meetings and Public Hearings..... [2813](#)

### CHRONOLOGICAL LIST

Open Meetings..... [2814](#)

Public Hearings..... [2816](#)

# CUMULATIVE TABLE OF VIRGINIA ADMINISTRATIVE CODE SECTIONS ADOPTED, AMENDED, OR REPEALED

The table printed below lists regulation sections, by Virginia Administrative Code (VAC) title, that have been amended, added or repealed in the *Virginia Register* since the regulations were originally published or last supplemented in VAC (the Spring 1998 VAC Supplement includes final regulations published through *Virginia Register* Volume 14, Issue 10 dated February 2, 1998). Emergency regulations, if any, are listed, followed by the designation "emer," and errata pertaining to final regulations are listed. Proposed regulations are not listed here. The table lists the sections in numerical order and shows action taken, the volume, issue and page number where the section appeared, and the effective date of the section.

SECTION NUMBER	ACTION	CITE	EFFECTIVE DATE
<b>Title 2. Agriculture</b>			
2 VAC 5-180-10	Amended	14:19 VA.R. 2666	7/8/98
2 VAC 5-180-20	Amended	14:19 VA.R. 2667	7/8/98
2 VAC 5-180-30	Amended	14:19 VA.R. 2668	7/8/98
2 VAC 5-180-50	Amended	14:19 VA.R. 2668	7/8/98
2 VAC 5-180-60	Amended	14:19 VA.R. 2668	7/8/98
2 VAC 5-180-80	Amended	14:19 VA.R. 2668	7/8/98
2 VAC 5-180-90	Amended	14:19 VA.R. 2669	7/8/98
2 VAC 5-180-120	Amended	14:19 VA.R. 2669	7/8/98
2 VAC 5-205-10 through 2 VAC 5-205-110	Added	14:19 VA.R. 2670	7/8/98
2 VAC 5-390-180	Amended	14:14 VA.R. 2136	3/1/98
<b>Title 4. Conservation and Natural Resources</b>			
4 VAC 15-290-140	Amended	14:16 VA.R. 2357	7/1/98
4 VAC 20-260-20	Amended	14:15 VA.R. 2231	3/13/98
4 VAC 20-280-10	Amended	14:16 VA.R. 2357	3/31/98
4 VAC 20-345-10	Added	14:15 VA.R. 2236	3/1/98
4 VAC 20-345-20	Added	14:15 VA.R. 2236	3/1/98
4 VAC 20-345-20	Amended	14:18 VA.R. 2513	5/4/98
4 VAC 20-345-30	Added	14:15 VA.R. 2236	3/1/98
4 VAC 20-345-40	Added	14:15 VA.R. 2237	3/1/98
4 VAC 20-345-40	Amended	14:18 VA.R. 2513	5/4/98
4 VAC 20-380-30	Amended	14:16 VA.R. 2357	3/31/98
4 VAC 20-380-60	Amended	14:16 VA.R. 2358	3/31/98
4 VAC 20-500-40	Amended	14:14 VA.R. 2137	3/1/98
4 VAC 20-560-10	Amended	14:18 VA.R. 2514	5/1/98
4 VAC 20-560-20	Amended	14:18 VA.R. 2514	5/1/98
4 VAC 20-560-40	Amended	14:18 VA.R. 2515	5/1/98
4 VAC 20-560-50	Amended	14:18 VA.R. 2516	5/1/98
4 VAC 20-620-50	Amended	14:16 VA.R. 2358	4/1/98
4 VAC 20-620-60	Amended	14:16 VA.R. 2358	4/1/98
4 VAC 20-880-40	Amended	14:14 VA.R. 2137	3/1/98
4 VAC 20-880-40	Amended	14:18 VA.R. 2516	5/1/98
4 VAC 20-880-50	Amended	14:14 VA.R. 2138	3/1/98
4 VAC 20-880-50	Amended	14:18 VA.R. 2517	5/1/98
4 VAC 20-910-45	Amended	14:12 VA.R. 1915	1/30/98
4 VAC 20-950-30	Amended	14:16 VA.R. 2358	4/1/98
4 VAC 20-950-45	Added	14:12 VA.R. 1915	1/30/98
4 VAC 20-950-45	Amended	14:16 VA.R. 2359	4/1/98
4 VAC 20-960-30	Amended	14:16 VA.R. 2359	4/1/98
4 VAC 20-960-45	Added	14:16 VA.R. 2359	4/1/98
4 VAC 20-1000-10	Added	14:12 VA.R. 1916	1/30/98
4 VAC 20-1000-20	Added	14:12 VA.R. 1916	1/30/98
4 VAC 20-1000-30	Added	14:12 VA.R. 1916	1/30/98

---

## Cumulative Table of VAC Sections Adopted, Amended, or Repealed

---

SECTION NUMBER	ACTION	CITE	EFFECTIVE DATE
4 VAC 20-1000-40	Added	14:12 VA.R. 1916	1/30/98
4 VAC 25-40-10	Amended	14:17 VA.R. 2428	7/1/98
4 VAC 25-40-20	Repealed	14:17 VA.R. 2430	7/1/98
4 VAC 25-40-25	Added	14:17 VA.R. 2430	7/1/98
4 VAC 25-40-30	Repealed	14:17 VA.R. 2430	7/1/98
4 VAC 25-40-40	Amended	14:17 VA.R. 2430	7/1/98
4 VAC 25-40-50	Amended	14:17 VA.R. 2430	7/1/98
4 VAC 25-40-60	Repealed	14:17 VA.R. 2431	7/1/98
4 VAC 25-40-70	Amended	14:17 VA.R. 2431	7/1/98
4 VAC 25-40-80	Repealed	14:17 VA.R. 2431	7/1/98
4 VAC 25-40-90	Amended	14:17 VA.R. 2431	7/1/98
4 VAC 25-40-100	Amended	14:17 VA.R. 2431	7/1/98
4 VAC 25-40-110	Amended	14:17 VA.R. 2432	7/1/98
4 VAC 25-40-120	Amended	14:17 VA.R. 2432	7/1/98
4 VAC 25-40-130	Amended	14:17 VA.R. 2432	7/1/98
4 VAC 25-40-140	Amended	14:17 VA.R. 2432	7/1/98
4 VAC 25-40-145	Added	14:17 VA.R. 2432	7/1/98
4 VAC 25-40-180	Amended	14:17 VA.R. 2432	7/1/98
4 VAC 25-40-200	Amended	14:17 VA.R. 2432	7/1/98
4 VAC 25-40-210	Amended	14:17 VA.R. 2432	7/1/98
4 VAC 25-40-220	Amended	14:17 VA.R. 2432	7/1/98
4 VAC 25-40-250	Amended	14:17 VA.R. 2432	7/1/98
4 VAC 25-40-270	Amended	14:17 VA.R. 2432	7/1/98
4 VAC 25-40-300	Amended	14:17 VA.R. 2432	7/1/98
4 VAC 25-40-310	Amended	14:17 VA.R. 2432	7/1/98
4 VAC 25-40-320	Repealed	14:17 VA.R. 2432	7/1/98
4 VAC 25-40-350	Amended	14:17 VA.R. 2432	7/1/98
4 VAC 25-40-385	Added	14:17 VA.R. 2433	7/1/98
4 VAC 25-40-388	Added	14:17 VA.R. 2433	7/1/98
4 VAC 25-40-390	Amended	14:17 VA.R. 2434	7/1/98
4 VAC 25-40-400	Amended	14:17 VA.R. 2434	7/1/98
4 VAC 25-40-440	Amended	14:17 VA.R. 2434	7/1/98
4 VAC 25-40-450	Amended	14:17 VA.R. 2434	7/1/98
4 VAC 25-40-460	Amended	14:17 VA.R. 2434	7/1/98
4 VAC 25-40-490	Amended	14:17 VA.R. 2434	7/1/98
4 VAC 25-40-500	Amended	14:17 VA.R. 2434	7/1/98
4 VAC 25-40-510	Amended	14:17 VA.R. 2434	7/1/98
4 VAC 25-40-520	Amended	14:17 VA.R. 2434	7/1/98
4 VAC 25-40-530	Amended	14:17 VA.R. 2434	7/1/98
4 VAC 25-40-540	Amended	14:17 VA.R. 2434	7/1/98
4 VAC 25-40-550	Amended	14:17 VA.R. 2434	7/1/98
4 VAC 25-40-590	Amended	14:17 VA.R. 2434	7/1/98
4 VAC 25-40-630	Amended	14:17 VA.R. 2434	7/1/98
4 VAC 25-40-660	Amended	14:17 VA.R. 2434	7/1/98
4 VAC 25-40-670	Amended	14:17 VA.R. 2435	7/1/98
4 VAC 25-40-690	Amended	14:17 VA.R. 2435	7/1/98
4 VAC 25-40-710	Amended	14:17 VA.R. 2435	7/1/98
4 VAC 25-40-720	Amended	14:17 VA.R. 2435	7/1/98
4 VAC 25-40-730	Repealed	14:17 VA.R. 2435	7/1/98
4 VAC 25-40-750	Repealed	14:17 VA.R. 2435	7/1/98
4 VAC 25-40-770	Amended	14:17 VA.R. 2435	7/1/98
4 VAC 25-40-780	Amended	14:17 VA.R. 2435	7/1/98
4 VAC 25-40-790	Amended	14:17 VA.R. 2436	7/1/98
4 VAC 25-40-800	Amended	14:17 VA.R. 2436	7/1/98
4 VAC 25-40-810	Amended	14:17 VA.R. 2437	7/1/98

## Cumulative Table of VAC Sections Adopted, Amended, or Repealed

SECTION NUMBER	ACTION	CITE	EFFECTIVE DATE
4 VAC 25-40-820	Amended	14:17 VA.R. 2437	7/1/98
4 VAC 25-40-830	Amended	14:17 VA.R. 2438	7/1/98
4 VAC 25-40-870	Amended	14:17 VA.R. 2438	7/1/98
4 VAC 25-40-880	Amended	14:17 VA.R. 2438	7/1/98
4 VAC 25-40-890	Amended	14:17 VA.R. 2438	7/1/98
4 VAC 25-40-895	Added	14:17 VA.R. 2438	7/1/98
4 VAC 25-40-900	Amended	14:17 VA.R. 2438	7/1/98
4 VAC 25-40-910	Amended	14:17 VA.R. 2438	7/1/98
4 VAC 25-40-920	Amended	14:17 VA.R. 2439	7/1/98
4 VAC 25-40-930	Amended	14:17 VA.R. 2439	7/1/98
4 VAC 25-40-940	Repealed	14:17 VA.R. 2439	7/1/98
4 VAC 25-40-960	Repealed	14:17 VA.R. 2439	7/1/98
4 VAC 25-40-970	Amended	14:17 VA.R. 2439	7/1/98
4 VAC 25-40-1030	Amended	14:17 VA.R. 2439	7/1/98
4 VAC 25-40-1100	Amended	14:17 VA.R. 2439	7/1/98
4 VAC 25-40-1130	Amended	14:17 VA.R. 2440	7/1/98
4 VAC 25-40-1140	Amended	14:17 VA.R. 2440	7/1/98
4 VAC 25-40-1180	Amended	14:17 VA.R. 2440	7/1/98
4 VAC 25-40-1210	Amended	14:17 VA.R. 2440	7/1/98
4 VAC 25-40-1220	Amended	14:17 VA.R. 2440	7/1/98
4 VAC 25-40-1250	Amended	14:17 VA.R. 2440	7/1/98
4 VAC 25-40-1260	Amended	14:17 VA.R. 2440	7/1/98
4 VAC 25-40-1280	Amended	14:17 VA.R. 2440	7/1/98
4 VAC 25-40-1300	Repealed	14:17 VA.R. 2440	7/1/98
4 VAC 25-40-1310	Repealed	14:17 VA.R. 2440	7/1/98
4 VAC 25-40-1320	Amended	14:17 VA.R. 2440	7/1/98
4 VAC 25-40-1340	Amended	14:17 VA.R. 2440	7/1/98
4 VAC 25-40-1370	Amended	14:17 VA.R. 2440	7/1/98
4 VAC 25-40-1490	Repealed	14:17 VA.R. 2440	7/1/98
4 VAC 25-40-1540	Amended	14:17 VA.R. 2440	7/1/98
4 VAC 25-40-1550	Amended	14:17 VA.R. 2440	7/1/98
4 VAC 25-40-1560	Amended	14:17 VA.R. 2441	7/1/98
4 VAC 25-40-1580	Amended	14:17 VA.R. 2441	7/1/98
4 VAC 25-40-1590	Amended	14:17 VA.R. 2441	7/1/98
4 VAC 25-40-1670	Amended	14:17 VA.R. 2441	7/1/98
4 VAC 25-40-1685	Added	14:17 VA.R. 2441	7/1/98
4 VAC 25-40-1690	Amended	14:17 VA.R. 2441	7/1/98
4 VAC 25-40-1740	Amended	14:17 VA.R. 2441	7/1/98
4 VAC 25-40-1780	Amended	14:17 VA.R. 2441	7/1/98
4 VAC 25-40-1785	Added	14:17 VA.R. 2442	7/1/98
4 VAC 25-40-1810	Amended	14:17 VA.R. 2442	7/1/98
4 VAC 25-40-1880	Amended	14:17 VA.R. 2442	7/1/98
4 VAC 25-40-1940	Repealed	14:17 VA.R. 2442	7/1/98
4 VAC 25-40-2010	Amended	14:17 VA.R. 2442	7/1/98
4 VAC 25-40-2015	Added	14:17 VA.R. 2442	7/1/98
4 VAC 25-40-2040	Amended	14:17 VA.R. 2442	7/1/98
4 VAC 25-40-2080	Amended	14:17 VA.R. 2442	7/1/98
4 VAC 25-40-2100	Amended	14:17 VA.R. 2442	7/1/98
4 VAC 25-40-2140	Amended	14:17 VA.R. 2442	7/1/98
4 VAC 25-40-2170	Amended	14:17 VA.R. 2442	7/1/98
4 VAC 25-40-2180	Amended	14:17 VA.R. 2442	7/1/98
4 VAC 25-40-2210	Amended	14:17 VA.R. 2442	7/1/98
4 VAC 25-40-2220	Amended	14:17 VA.R. 2442	7/1/98
4 VAC 25-40-2250	Amended	14:17 VA.R. 2442	7/1/98
4 VAC 25-40-2260	Repealed	14:17 VA.R. 2443	7/1/98

---

## Cumulative Table of VAC Sections Adopted, Amended, or Repealed

---

SECTION NUMBER	ACTION	CITE	EFFECTIVE DATE
4 VAC 25-40-2270	Amended	14:17 VA.R. 2443	7/1/98
4 VAC 25-40-2280	Amended	14:17 VA.R. 2443	7/1/98
4 VAC 25-40-2300	Amended	14:17 VA.R. 2443	7/1/98
4 VAC 25-40-2340	Amended	14:17 VA.R. 2443	7/1/98
4 VAC 25-40-2390	Amended	14:17 VA.R. 2443	7/1/98
4 VAC 25-40-2400	Amended	14:17 VA.R. 2443	7/1/98
4 VAC 25-40-2410	Amended	14:17 VA.R. 2443	7/1/98
4 VAC 25-40-2420	Amended	14:17 VA.R. 2443	7/1/98
4 VAC 25-40-2440	Amended	14:17 VA.R. 2443	7/1/98
4 VAC 25-40-2450	Amended	14:17 VA.R. 2443	7/1/98
4 VAC 25-40-2480	Amended	14:17 VA.R. 2443	7/1/98
4 VAC 25-40-2490	Amended	14:17 VA.R. 2443	7/1/98
4 VAC 25-40-2500	Amended	14:17 VA.R. 2443	7/1/98
4 VAC 25-40-2510	Repealed	14:17 VA.R. 2443	7/1/98
4 VAC 25-40-2530	Amended	14:17 VA.R. 2443	7/1/98
4 VAC 25-40-2540	Amended	14:17 VA.R. 2443	7/1/98
4 VAC 25-40-2550	Amended	14:17 VA.R. 2443	7/1/98
4 VAC 25-40-2590	Amended	14:17 VA.R. 2444	7/1/98
4 VAC 25-40-2610	Amended	14:17 VA.R. 2444	7/1/98
4 VAC 25-40-2650	Amended	14:17 VA.R. 2444	7/1/98
4 VAC 25-40-2660	Amended	14:17 VA.R. 2444	7/1/98
4 VAC 25-40-2680	Amended	14:17 VA.R. 2444	7/1/98
4 VAC 25-40-2700	Amended	14:17 VA.R. 2444	7/1/98
4 VAC 25-40-2720	Amended	14:17 VA.R. 2444	7/1/98
4 VAC 25-40-2750	Amended	14:17 VA.R. 2444	7/1/98
4 VAC 25-40-2760	Amended	14:17 VA.R. 2444	7/1/98
4 VAC 25-40-2770	Amended	14:17 VA.R. 2444	7/1/98
4 VAC 25-40-2790	Amended	14:17 VA.R. 2444	7/1/98
4 VAC 25-40-2800	Amended	14:17 VA.R. 2445	7/1/98
4 VAC 25-40-2810	Amended	14:17 VA.R. 2445	7/1/98
4 VAC 25-40-2820	Amended	14:17 VA.R. 2445	7/1/98
4 VAC 25-40-2850	Amended	14:17 VA.R. 2445	7/1/98
4 VAC 25-40-2870	Amended	14:17 VA.R. 2445	7/1/98
4 VAC 25-40-2880	Amended	14:17 VA.R. 2445	7/1/98
4 VAC 25-40-2910	Amended	14:17 VA.R. 2445	7/1/98
4 VAC 25-40-2915	Added	14:17 VA.R. 2445	7/1/98
4 VAC 25-40-2920	Amended	14:17 VA.R. 2445	7/1/98
4 VAC 25-40-2930	Amended	14:17 VA.R. 2445	7/1/98
4 VAC 25-40-2980	Amended	14:17 VA.R. 2445	7/1/98
4 VAC 25-40-3000	Amended	14:17 VA.R. 2445	7/1/98
4 VAC 25-40-3030	Amended	14:17 VA.R. 2446	7/1/98
4 VAC 25-40-3050	Amended	14:17 VA.R. 2446	7/1/98
4 VAC 25-40-3070	Amended	14:17 VA.R. 2446	7/1/98
4 VAC 25-40-3080	Amended	14:17 VA.R. 2446	7/1/98
4 VAC 25-40-3110	Amended	14:17 VA.R. 2446	7/1/98
4 VAC 25-40-3120	Amended	14:17 VA.R. 2446	7/1/98
4 VAC 25-40-3160	Amended	14:17 VA.R. 2447	7/1/98
4 VAC 25-40-3170	Amended	14:17 VA.R. 2447	7/1/98
4 VAC 25-40-3220	Amended	14:17 VA.R. 2447	7/1/98
4 VAC 25-40-3230	Repealed	14:17 VA.R. 2447	7/1/98
4 VAC 25-40-3240	Amended	14:17 VA.R. 2447	7/1/98
4 VAC 25-40-3280	Amended	14:17 VA.R. 2447	7/1/98
4 VAC 25-40-3290	Amended	14:17 VA.R. 2447	7/1/98
4 VAC 25-40-3300	Amended	14:17 VA.R. 2447	7/1/98
4 VAC 25-40-3310	Amended	14:17 VA.R. 2447	7/1/98



## Cumulative Table of VAC Sections Adopted, Amended, or Repealed

SECTION NUMBER	ACTION	CITE	EFFECTIVE DATE
4 VAC 25-40-3320	Amended	14:17 VA.R. 2447	7/1/98
4 VAC 25-40-3325	Added	14:17 VA.R. 2447	7/1/98
4 VAC 25-40-3328	Added	14:17 VA.R. 2447	7/1/98
4 VAC 25-40-3330	Amended	14:17 VA.R. 2447	7/1/98
4 VAC 25-40-3340	Amended	14:17 VA.R. 2447	7/1/98
4 VAC 25-40-3350	Amended	14:17 VA.R. 2447	7/1/98
4 VAC 25-40-3420	Amended	14:17 VA.R. 2447	7/1/98
4 VAC 25-40-3430	Amended	14:17 VA.R. 2448	7/1/98
4 VAC 25-40-3450	Amended	14:17 VA.R. 2448	7/1/98
4 VAC 25-40-3460	Amended	14:17 VA.R. 2448	7/1/98
4 VAC 25-40-3475	Added	14:17 VA.R. 2448	7/1/98
4 VAC 25-40-3478	Added	14:17 VA.R. 2448	7/1/98
4 VAC 25-40-3595	Added	14:17 VA.R. 2448	7/1/98
4 VAC 25-40-3620	Amended	14:17 VA.R. 2448	7/1/98
4 VAC 25-40-3660	Amended	14:17 VA.R. 2448	7/1/98
4 VAC 25-40-3690	Amended	14:17 VA.R. 2448	7/1/98
4 VAC 25-40-3700	Amended	14:17 VA.R. 2448	7/1/98
4 VAC 25-40-3710	Amended	14:17 VA.R. 2448	7/1/98
4 VAC 25-40-3720	Amended	14:17 VA.R. 2448	7/1/98
4 VAC 25-40-3830	Amended	14:17 VA.R. 2448	7/1/98
4 VAC 25-40-3840	Amended	14:17 VA.R. 2449	7/1/98
4 VAC 25-40-3855	Added	14:17 VA.R. 2449	7/1/98
4 VAC 25-40-3890	Amended	14:17 VA.R. 2449	7/1/98
4 VAC 25-40-3930	Amended	14:17 VA.R. 2449	7/1/98
4 VAC 25-40-3955	Added	14:17 VA.R. 2449	7/1/98
4 VAC 25-40-3958	Added	14:17 VA.R. 2450	7/1/98
4 VAC 25-40-3980	Amended	14:17 VA.R. 2450	7/1/98
4 VAC 25-40-3990	Amended	14:17 VA.R. 2450	7/1/98
4 VAC 25-40-4060	Amended	14:17 VA.R. 2450	7/1/98
4 VAC 25-40-4090	Amended	14:17 VA.R. 2450	7/1/98
4 VAC 25-40-4100	Amended	14:17 VA.R. 2450	7/1/98
4 VAC 25-40-4110	Amended	14:17 VA.R. 2451	7/1/98
4 VAC 25-40-4140	Amended	14:17 VA.R. 2451	7/1/98
4 VAC 25-40-4160	Amended	14:17 VA.R. 2451	7/1/98
4 VAC 25-40-4220	Amended	14:17 VA.R. 2451	7/1/98
4 VAC 25-40-4230	Amended	14:17 VA.R. 2451	7/1/98
4 VAC 25-40-4260	Amended	14:17 VA.R. 2451	7/1/98
4 VAC 25-40-4280	Amended	14:17 VA.R. 2451	7/1/98
4 VAC 25-40-4290	Amended	14:17 VA.R. 2452	7/1/98
4 VAC 25-40-4320	Amended	14:17 VA.R. 2452	7/1/98
4 VAC 25-40-4330	Amended	14:17 VA.R. 2452	7/1/98
4 VAC 25-40-4350	Amended	14:17 VA.R. 2452	7/1/98
4 VAC 25-40-4430	Amended	14:17 VA.R. 2452	7/1/98
4 VAC 25-40-4440	Amended	14:17 VA.R. 2452	7/1/98
4 VAC 25-40-4460	Amended	14:17 VA.R. 2452	7/1/98
4 VAC 25-40-4540	Amended	14:17 VA.R. 2452	7/1/98
4 VAC 25-40-4590	Amended	14:17 VA.R. 2452	7/1/98
4 VAC 25-40-4650	Amended	14:17 VA.R. 2452	7/1/98
4 VAC 25-40-4750	Amended	14:17 VA.R. 2452	7/1/98
4 VAC 25-40-4770	Amended	14:17 VA.R. 2452	7/1/98
4 VAC 25-40-4910	Amended	14:17 VA.R. 2452	7/1/98
4 VAC 25-40-4920	Amended	14:17 VA.R. 2452	7/1/98
4 VAC 25-40-4970	Amended	14:17 VA.R. 2452	7/1/98
4 VAC 25-40-4980	Amended	14:17 VA.R. 2452	7/1/98
4 VAC 25-40-5040	Repealed	14:17 VA.R. 2452	7/1/98

---

## Cumulative Table of VAC Sections Adopted, Amended, or Repealed

---

SECTION NUMBER	ACTION	CITE	EFFECTIVE DATE
4 VAC 25-40-5050	Repealed	14:17 VA.R. 2453	7/1/98
4 VAC 25-40-5060	Amended	14:17 VA.R. 2453	7/1/98
4 VAC 25-40-5070	Amended	14:17 VA.R. 2453	7/1/98
4 VAC 25-40-5120	Amended	14:17 VA.R. 2453	7/1/98
4 VAC 25-40-5170	Amended	14:17 VA.R. 2453	7/1/98
4 VAC 25-40-5180	Amended	14:17 VA.R. 2453	7/1/98
4 VAC 25-40-5200	Amended	14:17 VA.R. 2453	7/1/98
4 VAC 25-40-5210	Amended	14:17 VA.R. 2453	7/1/98
4 VAC 25-40-5230	Amended	14:17 VA.R. 2454	7/1/98
4 VAC 25-40-5290	Amended	14:17 VA.R. 2454	7/1/98
4 VAC 25-40-5310	Amended	14:17 VA.R. 2454	7/1/98
4 VAC 25-40-5320	Amended	14:17 VA.R. 2454	7/1/98
4 VAC 25-40-5330	Amended	14:17 VA.R. 2454	7/1/98
4 VAC 25-40-5340	Amended	14:17 VA.R. 2454	7/1/98
4 VAC 25-40-5370	Amended	14:17 VA.R. 2454	7/1/98
4 VAC 25-40-5400	Amended	14:17 VA.R. 2454	7/1/98
4 VAC 25-40-5450	Amended	14:17 VA.R. 2454	7/1/98
4 VAC 25-40-5470	Amended	14:17 VA.R. 2454	7/1/98
4 VAC 25-40-5550	Amended	14:17 VA.R. 2454	7/1/98
4 VAC 25-40-5580	Amended	14:17 VA.R. 2454	7/1/98
4 VAC 25-40-5590	Amended	14:17 VA.R. 2455	7/1/98
4 VAC 25-40-5630	Amended	14:17 VA.R. 2455	7/1/98
4 VAC 25-40-5660	Amended	14:17 VA.R. 2455	7/1/98
4 VAC 25-40-5670	Amended	14:17 VA.R. 2455	7/1/98
4 VAC 25-40-5680	Repealed	14:17 VA.R. 2455	7/1/98
4 VAC 25-40-5690	Repealed	14:17 VA.R. 2455	7/1/98
4 VAC 25-40-5710	Amended	14:17 VA.R. 2455	7/1/98
4 VAC 25-40-5720	Repealed	14:17 VA.R. 2455	7/1/98
4 VAC 25-40-5730	Repealed	14:17 VA.R. 2455	7/1/98
4 VAC 25-40-5740	Repealed	14:17 VA.R. 2456	7/1/98
4 VAC 25-40-5750	Added	14:17 VA.R. 2456	7/1/98
4 VAC 25-40-5760	Added	14:17 VA.R. 2456	7/1/98
4 VAC 25-40-5770	Added	14:17 VA.R. 2457	7/1/98
4 VAC 25-40-5780	Added	14:17 VA.R. 2457	7/1/98
<b>Title 6. Criminal Justice and Corrections</b>			
6 VAC 15-60-10 through	Repealed	14:17 VA.R. 2457	9/1/98
6 VAC 15-60-100			
6 VAC 15-61-10 through	Added	14:17 VA.R. 2457	9/1/98
6 VAC 15-61-300			
<b>Title 9. Environment</b>			
9 VAC 5-20-203	Amended	14:11 VA.R. 1804	4/1/98
9 VAC 5-20-204	Amended	14:11 VA.R. 1804	4/1/98
9 VAC 5-20-205	Amended	14:11 VA.R. 1805	4/1/98
9 VAC 5-20-220	Added	14:11 VA.R. 1812	4/1/98
9 VAC 5-20-230	Added	14:11 VA.R. 1812	4/1/98
9 VAC 5-50-400	Amended	14:11 VA.R. 1807	4/1/98
9 VAC 5-60-60	Amended	14:11 VA.R. 1807	4/1/98
9 VAC 5-60-90	Amended	14:11 VA.R. 1807	4/1/98
9 VAC 5-60-100	Amended	14:11 VA.R. 1808	4/1/98
9 VAC 5-80-40	Repealed	14:11 VA.R. 1813	4/1/98
9 VAC 5-80-800	Added	14:11 VA.R. 1820	4/1/98
9 VAC 5-80-810	Added	14:11 VA.R. 1820	4/1/98
9 VAC 5-80-820	Added	14:11 VA.R. 1822	4/1/98
9 VAC 5-80-830	Added	14:11 VA.R. 1823	4/1/98
9 VAC 5-80-840	Added	14:11 VA.R. 1823	4/1/98

# Cumulative Table of VAC Sections Adopted, Amended, or Repealed

SECTION NUMBER	ACTION	CITE	EFFECTIVE DATE
9 VAC 5-80-850	Added	14:11 VA.R. 1823	4/1/98
9 VAC 5-80-860	Added	14:11 VA.R. 1825	4/1/98
9 VAC 5-80-870	Added	14:11 VA.R. 1825	4/1/98
9 VAC 5-80-880	Added	14:11 VA.R. 1825	4/1/98
9 VAC 5-80-890	Added	14:11 VA.R. 1826	4/1/98
9 VAC 5-80-900	Added	14:11 VA.R. 1826	4/1/98
9 VAC 5-80-910	Added	14:11 VA.R. 1826	4/1/98
9 VAC 5-80-920	Added	14:11 VA.R. 1826	4/1/98
9 VAC 5-80-930	Added	14:11 VA.R. 1826	4/1/98
9 VAC 5-80-940	Added	14:11 VA.R. 1826	4/1/98
9 VAC 5-80-950	Added	14:11 VA.R. 1826	4/1/98
9 VAC 5-80-960	Added	14:11 VA.R. 1826	4/1/98
9 VAC 5-80-970	Added	14:11 VA.R. 1827	4/1/98
9 VAC 5-80-980	Added	14:11 VA.R. 1827	4/1/98
9 VAC 5-80-990	Added	14:11 VA.R. 1828	4/1/98
9 VAC 5-80-1000	Added	14:11 VA.R. 1828	4/1/98
9 VAC 5-80-1010	Added	14:11 VA.R. 1828	4/1/98
9 VAC 5-80-1020	Added	14:11 VA.R. 1829	4/1/98
9 VAC 5-80-1030	Added	14:11 VA.R. 1830	4/1/98
9 VAC 5-80-1040	Added	14:11 VA.R. 1831	4/1/98
9 VAC 5-190-80	Erratum	14:12 VA.R. 1937	--
9 VAC 25-31-800	Erratum	14:12 VA.R. 1937	--
9 VAC 25-31-800	Erratum	14:17 VA.R. 2477	--
9 VAC 25-31-840	Erratum	14:12 VA.R. 1937	--
9 VAC 25-31-900	Erratum	14:17 VA.R. 2477	--
9 VAC 25-31-920	Amended	14:16 VA.R. 2360	5/27/98
9 VAC 25-90-10 through 9 VAC 25-90-70	Repealed	14:18 VA.R. 2517	6/24/98
9 VAC 25-91-10 through 9 VAC 25-91-220	Added	14:18 VA.R. 2518	6/24/98
9 VAC 25-100-10 through 9 VAC 25-100-70	Repealed	14:18 VA.R. 2547	6/24/98
9 VAC 25-101-10 through 9 VAC 25-101-70	Added	14:18 VA.R. 2547	6/24/98
9 VAC 25-130-10 through 9 VAC 25-130-100	Repealed	14:18 VA.R. 2517	6/24/98
9 VAC 25-140-10 through 9 VAC 25-140-110	Repealed	14:18 VA.R. 2518	6/24/98
9 VAC 25-196-50	Erratum	14:12 VA.R. 1937	--
9 VAC 25-196-70	Erratum	14:12 VA.R. 1937	--
9 VAC 25-260-20	Erratum	14:12 VA.R. 1937	--
9 VAC 25-260-110	Erratum	14:12 VA.R. 1937	--
9 VAC 25-260-140	Erratum	14:12 VA.R. 1937	--
9 VAC 25-260-350	Erratum	14:12 VA.R. 1937	--
9 VAC 25-260-370	Erratum	14:12 VA.R. 1937	--
9 VAC 25-260-390	Erratum	14:12 VA.R. 1937	--
9 VAC 25-260-400	Erratum	14:12 VA.R. 1937	--
9 VAC 25-260-450	Erratum	14:12 VA.R. 1937	--
9 VAC 25-260-540	Erratum	14:12 VA.R. 1937	--
<b>Title 10. Finance and Financial Institutions</b>			
10 VAC 5-60-40	Amended	14:14 VA.R. 2139	3/10/98
10 VAC 5-60-50	Amended	14:14 VA.R. 2139	3/10/98
10 VAC 5-70-20	Amended	14:14 VA.R. 2140	3/10/98
10 VAC 5-70-30	Amended	14:14 VA.R. 2140	3/10/98
10 VAC 5-70-50	Amended	14:14 VA.R. 2140	3/10/98

---

## Cumulative Table of VAC Sections Adopted, Amended, or Repealed

---

SECTION NUMBER	ACTION	CITE	EFFECTIVE DATE
<b>Title 11. Gaming</b>			
11 VAC 10-70-20	Amended	14:11 VA.R. 1831	3/19/98
11 VAC 10-70-30	Amended	14:11 VA.R. 1831	3/19/98
11 VAC 10-70-40	Amended	14:11 VA.R. 1831	3/19/98
11 VAC 10-70-50	Amended	14:11 VA.R. 1831	3/19/98
11 VAC 10-70-60	Amended	14:11 VA.R. 1832	3/19/98
11 VAC 10-70-70	Amended	14:11 VA.R. 1832	3/19/98
11 VAC 10-70-80	Amended	14:11 VA.R. 1833	3/19/98
11 VAC 10-70-110	Amended	14:11 VA.R. 1833	3/19/98
11 VAC 10-70-170	Amended	14:11 VA.R. 1833	3/19/98
11 VAC 10-70-180	Amended	14:11 VA.R. 1833	3/19/98
11 VAC 10-90-10	Amended	14:11 VA.R. 1835	3/19/98
11 VAC 10-90-20	Amended	14:11 VA.R. 1835	3/19/98
11 VAC 10-90-30	Amended	14:11 VA.R. 1835	3/19/98
11 VAC 10-90-40	Amended	14:11 VA.R. 1835	3/19/98
11 VAC 10-90-50	Amended	14:11 VA.R. 1835	3/19/98
11 VAC 10-90-60	Amended	14:11 VA.R. 1836	3/19/98
<b>Title 12. Health</b>			
12 VAC 5-210-10	Amended	14:15 VA.R. 2237	6/1/98
12 VAC 5-210-20	Amended	14:15 VA.R. 2243	6/1/98
12 VAC 5-220-10	Amended	14:12 VA.R. 1917	4/2/98
12 VAC 5-220-105	Added	14:12 VA.R. 1920	4/2/98
12 VAC 5-220-150	Amended	14:12 VA.R. 1920	4/2/98
12 VAC 5-220-180	Amended	14:12 VA.R. 1920	4/2/98
12 VAC 5-220-200	Amended	14:12 VA.R. 1921	4/2/98
12 VAC 5-220-230	Amended	14:12 VA.R. 1923	4/2/98
12 VAC 5-220-280	Amended	14:12 VA.R. 1924	4/2/98
12 VAC 5-220-290	Amended	14:12 VA.R. 1925	4/2/98
12 VAC 5-220-385	Amended	14:12 VA.R. 1925	4/2/98
12 VAC 5-220-500	Amended	14:12 VA.R. 1926	4/2/98
12 VAC 30-50-30	Amended	14:18 VA.R. 2568	7/1/98
12 VAC 30-50-70	Amended	14:18 VA.R. 2568	7/1/98
12 VAC 30-50-100	Amended	14:18 VA.R. 2571	7/1/98
12 VAC 30-50-105	Amended	14:18 VA.R. 2573	7/1/98
12 VAC 30-50-140	Amended	14:12 VA.R. 1926	4/1/98
12 VAC 30-50-140	Amended	14:18 VA.R. 2574	7/1/98
12 VAC 30-50-150	Amended	14:12 VA.R. 1927	4/1/98
12 VAC 30-50-160	Amended	14:18 VA.R. 2564	7/1/98
12 VAC 30-50-200	Amended	14:18 VA.R. 2579	7/1/98
12 VAC 30-50-220	Amended	14:18 VA.R. 2569	7/1/98
12 VAC 30-50-229.1	Added	14:18 VA.R. 2581	7/1/98
12 VAC 30-50-540	Amended	14:18 VA.R. 2575	7/1/98
12 VAC 30-50-550	Added	14:18 VA.R. 2576	7/1/98
12 VAC 30-50-560	Added	14:18 VA.R. 2577	7/1/98
12 VAC 30-50-570	Added	14:18 VA.R. 2578	7/1/98
12 VAC 30-60-40	Amended	14:12 VA.R. 1928	4/1/98
12 VAC 30-60-90	Repealed	14:17 VA.R. 2465	6/10/98
12 VAC 30-60-120	Amended	14:12 VA.R. 1929	4/1/98
12 VAC 30-70-440	Repealed	14:15 VA.R. 2248	6/1/98
12 VAC 30-70-441	Added	14:15 VA.R. 2248	6/1/98
12 VAC 30-80-30	Amended	14:12 VA.R. 1933	4/1/98
12 VAC 30-80-30	Amended	14:18 VA.R. 2582	7/1/98
12 VAC 30-100-120	Amended	14:18 VA.R. 2583	7/1/98
12 VAC 30-120-360	Amended	14:18 VA.R. 2584	7/1/98
12 VAC 30-120-370	Amended	14:18 VA.R. 2585	7/1/98

# Cumulative Table of VAC Sections Adopted, Amended, or Repealed

SECTION NUMBER	ACTION	CITE	EFFECTIVE DATE
12 VAC 30-120-385	Added	14:18 VA.R. 2587	7/1/98
12 VAC 30-120-410	Amended	14:18 VA.R. 2587	7/1/98
12 VAC 30-120-420	Amended	14:18 VA.R. 2587	7/1/98
12 VAC 30-120-490 through 12 VAC 30-120-550	Added	14:18 VA.R. 2590	7/1/98
<b>Title 13. Housing</b>			
13 VAC 5-51-135 emer	Added	14:18 VA.R. 2605	4/27/98 - 4/26/99
13 VAC 5-61-440	Amended	14:18 VA.R. 2600	7/1/98
13 VAC 10-10-20	Amended	14:17 VA.R. 2466	5/1/98
13 VAC 10-20-20	Amended	14:17 VA.R. 2467	5/1/98
13 VAC 10-40-100	Amended	14:11 VA.R. 1838	1/28/98
13 VAC 10-40-110	Amended	14:11 VA.R. 1839	1/28/98
13 VAC 10-40-120	Amended	14:11 VA.R. 1839	1/28/98
13 VAC 10-40-130	Amended	14:11 VA.R. 1839	1/28/98
13 VAC 10-40-140	Amended	14:11 VA.R. 1841	1/28/98
13 VAC 10-40-190	Amended	14:11 VA.R. 1842	1/28/98
13 VAC 10-40-210	Amended	14:11 VA.R. 1843	1/28/98
13 VAC 10-40-230	Added	14:11 VA.R. 1843	1/28/98
13 VAC 10-130-30	Amended	14:17 VA.R. 2468	5/1/98
13 VAC 10-140-20	Amended	14:17 VA.R. 2469	5/1/98
13 VAC 10-180-50	Amended	14:14 VA.R. 2141	3/4/98
13 VAC 10-180-60	Amended	14:14 VA.R. 2142	3/4/98
<b>Title 16. Labor and Employment</b>			
16 VAC 25-90-1910.94	Amended	14:15 VA.R. 2250	6/1/98
16 VAC 25-90-1910.111	Amended	14:15 VA.R. 2250	6/1/98
16 VAC 25-90-1910.134	Amended	14:15 VA.R. 2250	6/1/98
16 VAC 25-90-1910.139	Added	14:15 VA.R. 2250	6/1/98
16 VAC 25-90-1910.156	Amended	14:15 VA.R. 2250	6/1/98
16 VAC 25-90-1910.252	Amended	14:15 VA.R. 2250	6/1/98
16 VAC 25-90-1910.261	Erratum	14:17 VA.R. 2477	6/1/98
16 VAC 25-90-1910.1001	Amended	14:15 VA.R. 2250	6/1/98
16 VAC 25-90-1910.1003	Amended	14:15 VA.R. 2250	6/1/98
16 VAC 25-90-1910.1017	Amended	14:15 VA.R. 2250	6/1/98
16 VAC 25-90-1910.1018	Amended	14:15 VA.R. 2250	6/1/98
16 VAC 25-90-1910.1025	Amended	14:15 VA.R. 2250	6/1/98
16 VAC 25-90-1910.1027	Amended	14:15 VA.R. 2250	6/1/98
16 VAC 25-90-1910.1028	Amended	14:15 VA.R. 2250	6/1/98
16 VAC 25-90-1910.1029	Amended	14:15 VA.R. 2250	6/1/98
16 VAC 25-90-1910.1043	Amended	14:15 VA.R. 2250	6/1/98
16 VAC 25-90-1910.1044	Amended	14:15 VA.R. 2250	6/1/98
16 VAC 25-90-1910.1045	Amended	14:15 VA.R. 2250	6/1/98
16 VAC 25-90-1910.1047	Amended	14:15 VA.R. 2250	6/1/98
16 VAC 25-90-1910.1048	Amended	14:15 VA.R. 2250	6/1/98
16 VAC 25-90-1910.1050	Amended	14:15 VA.R. 2250	6/1/98
16 VAC 25-90-1910.1051	Amended	14:15 VA.R. 2250	6/1/98
16 VAC 25-90-1910.1052	Amended	14:14 VA.R. 2151	5/1/98
16 VAC 25-90-1910.1052	Amended	14:15 VA.R. 2250	6/1/98
<b>Title 18. Professional and Occupational Licensing</b>			
18 VAC 25-21-70	Amended	14:11 VA.R. 1845	4/1/98
18 VAC 30-20-10	Amended	14:14 VA.R. 2155	4/29/98
18 VAC 30-20-20	Repealed	14:14 VA.R. 2156	4/29/98
18 VAC 30-20-30	Repealed	14:14 VA.R. 2156	4/29/98
18 VAC 30-20-40	Repealed	14:14 VA.R. 2156	4/29/98
18 VAC 30-20-45	Added	14:14 VA.R. 2156	4/29/98
18 VAC 30-20-50	Amended	14:14 VA.R. 2156	4/29/98

---

## Cumulative Table of VAC Sections Adopted, Amended, or Repealed

---

SECTION NUMBER	ACTION	CITE	EFFECTIVE DATE
18 VAC 30-20-60	Repealed	14:14 VA.R. 2156	4/29/98
18 VAC 30-20-70	Amended	14:14 VA.R. 2156	4/29/98
18 VAC 30-20-80	Amended	14:14 VA.R. 2157	4/29/98
18 VAC 30-20-90	Repealed	14:14 VA.R. 2157	4/29/98
18 VAC 30-20-100	Repealed	14:14 VA.R. 2157	4/29/98
18 VAC 30-20-110	Repealed	14:14 VA.R. 2157	4/29/98
18 VAC 30-20-120	Repealed	14:14 VA.R. 2157	4/29/98
18 VAC 30-20-130	Repealed	14:14 VA.R. 2157	4/29/98
18 VAC 30-20-140	Repealed	14:14 VA.R. 2157	4/29/98
18 VAC 30-20-150	Amended	14:14 VA.R. 2157	4/29/98
18 VAC 30-20-160	Amended	14:14 VA.R. 2157	4/29/98
18 VAC 30-20-170	Amended	14:14 VA.R. 2157	4/29/98
18 VAC 30-20-180	Amended	14:14 VA.R. 2159	4/29/98
18 VAC 30-20-190	Repealed	14:14 VA.R. 2159	4/29/98
18 VAC 30-20-200	Repealed	14:14 VA.R. 2159	4/29/98
18 VAC 30-20-210	Repealed	14:14 VA.R. 2159	4/29/98
18 VAC 30-20-220	Repealed	14:14 VA.R. 2159	4/29/98
18 VAC 30-20-240	Amended	14:14 VA.R. 2159	4/29/98
18 VAC 30-20-250	Repealed	14:14 VA.R. 2160	4/29/98
18 VAC 30-20-260	Repealed	14:14 VA.R. 2160	4/29/98
18 VAC 30-20-270	Repealed	14:14 VA.R. 2160	4/29/98
18 VAC 30-20-280	Amended	14:14 VA.R. 2160	4/29/98
18 VAC 60-20-105	Added	14:18 VA.R. 2602	6/24/98
18 VAC 76-10-10	Amended	14:11 VA.R. 1845	1/22/98
18 VAC 110-20-210	Amended	14:15 VA.R. 2253	5/13/98
18 VAC 120-30-100	Amended	14:11 VA.R. 1846	4/1/98
18 VAC 125-20-30	Amended	14:11 VA.R. 1851	4/1/98
<b>Title 19. Public Safety</b>			
19 VAC 30-20-10	Amended	14:11 VA.R. 1853	3/18/98
19 VAC 30-20-70	Amended	14:11 VA.R. 1853	3/18/98
19 VAC 30-20-80	Amended	14:11 VA.R. 1854	3/18/98
19 VAC 30-20-140	Amended	14:11 VA.R. 1854	3/18/98
19 VAC 30-20-150	Amended	14:11 VA.R. 1854	3/18/98
19 VAC 30-20-160	Amended	14:11 VA.R. 1854	3/18/98
<b>Title 20. Public Utilities and Telecommunications</b>			
20 VAC 5-310-10	Amended	14:15 VA.R. 2253	3/24/98
<b>Title 21. Securities and Retail Franchising</b>			
21 VAC 5-85-10	Amended	14:13 VA.R. 1976	2/17/98
21 VAC 5-85-10	Amended	14:15 VA.R. 2259	3/24/98
<b>Title 24. Transportation</b>			
24 VAC 30-71-160	Erratum	14:13 VA.R. 2011	--
24 VAC 30-71-170	Erratum	14:13 VA.R. 2028	--
24 VAC 30-170-10	Amended	14:13 VA.R. 1992	4/15/98
24 VAC 30-380-10	Amended	14:13 VA.R. 1992	2/24/98
24 VAC 30-390-10	Amended	14:13 VA.R. 1992	2/24/98

---

# PUBLIC COMMENT PERIODS - PROPOSED REGULATIONS

---



## PUBLIC COMMENT PERIODS REGARDING STATE AGENCY REGULATIONS

This section gives notice of public comment periods and public hearings to be held on proposed regulations. The notice will be published once at the same time the proposed regulation is published in the Proposed Regulations section of the *Virginia Register*. The notice will continue to be carried in the Calendar of Events section of the *Virginia Register* until the public comment period and public hearing date have passed.

Notice is given in compliance with § 9-6.14:7.1 of the Code of Virginia that the following public hearings and public comment periods regarding proposed state agency regulations are set to afford the public an opportunity to express their views.

## TITLE 19. PUBLIC SAFETY

### DEPARTMENT OF STATE POLICE

**August 21, 1998** – Public comments may be submitted through this date.

Notice is hereby given in accordance with § 9-6.14:7.1 of the Code of Virginia that the Department of State Police intends to amend regulations entitled: **19 VAC 30-70-1 et seq. Motor Vehicle Safety Inspection Rules and Regulations.** The purpose of the proposed action is to amend existing administrative regulations governing vehicle inspections to comply with mandates of the amended sections of the Code of Federal Regulations and the Code of Virginia.

Statutory Authority: § 46.2-1165 of the Code of Virginia.

**Contact:** Captain W. Steven Flaherty, Safety Officer, Department of State Police, P.O. Box 27472, Richmond, VA 23261, telephone (804) 378-3479, FAX (804) 378-3487 or toll-free 1-800-553-3144.

---

# PROPOSED REGULATIONS

---

For information concerning Proposed Regulations, see Information Page.

---

## Symbol Key

Roman type indicates existing text of regulations. *Italic type* indicates proposed new text.  
Language which has been stricken indicates proposed text for deletion.

---

## TITLE 19. PUBLIC SAFETY.

### DEPARTMENT OF STATE POLICE

Title of Regulation: **19 VAC 30-70-1 et seq. Motor Vehicle Safety Inspection Rules and Regulations (amending 19 VAC 30-70-5, 19 VAC 30-70-7, 19 VAC 30-70-10, 19 VAC 30-70-50, 19 VAC 30-70-70, 19 VAC 30-70-80, 19 VAC 30-70-90, 19 VAC 30-70-100, 19 VAC 30-70-140, 19 VAC 30-70-160, 19 VAC 30-70-180, 19 VAC 30-70-200, 19 VAC 30-70-440, 19 VAC 30-70-450, 19 VAC 30-70-460, 19 VAC 30-70-470, 19 VAC 30-70-480, 19 VAC 30-70-490, 19 VAC 30-70-500, 19 VAC 30-70-550, 19 VAC 30-70-570, 19 VAC 30-70-580 and 19 VAC 30-70-680).**

Statutory Authority: § 46.2-1165 of the Code of Virginia.

Public Hearing Date: N/A--Public comments may be submitted until August 21, 1998.

(See Calendar of Events section for additional information)

Basis: Section 46.2-1165 of the Code of Virginia requires the Superintendent of State Police to promulgate regulations for the inspection of motor vehicles.

Purpose: The purpose of the amendments is to comply with the mandates of the amended sections of the Code of Federal Regulations and the Code of Virginia. The Virginia Official Inspection Manual has been in place for over 60 years since the inception of the Inspection Program. Due to concerns for highway safety, the legislature determined that automobiles should be inspected annually to detect mechanical failures before they contribute to the cause of traffic crashes. This program has a significant impact upon the citizenry of the Commonwealth and is beneficial for their health, safety and welfare.

Substance: The proposed changes make minor modifications to portions of the language already in the Inspection Manual to comply with current federal and state law.

1. 19 VAC 30-70-5 seeks to revise an error in the last publication;
2. 19 VAC 30-70-7 adds a sentence to clarify the reinstatement process for a suspended inspector;
3. 19 VAC 30-70-10 T is revised to add the supervisory rank of sergeant to the list of state police supervisors who have authority to suspend a station or inspector;
4. 19 VAC 30-70-50 requires requests for supplies to be picked up at Safety Division headquarters to be made at least 24 hours in advance, and receipts and decals be placed in numerical order;

5. 19 VAC 30-70-70 is amended by deleting the reference to the back page of the Inventory Report (Form SP221);

6. 19 VAC 30-70-80 eliminates the reference to the decelerometer or brake machine and clarifies the condition requiring rejection following the remachining of brake drums or brake disks;

7. 19 VAC 30-70-90 adds a subsection to provide for a procedure for checking the holding brake (consistent with the CFR);

8. 19 VAC 30-70-100 deletes a section relating to decelerometers and renumbers some subsections;

9. 19 VAC 30-70-140 is amended to delete mechanical aimers;

10. 19 VAC 30-70-160 is amended to clarify which fog lamps and driving lamps require aiming;

11. 19 VAC 30-70-180 is amended to show the minimum height for reflector placement as 15 inches;

12. 19 VAC 30-70-200 eliminates reference to magneto or acetylene light and front fender jewels, and renumbers some subdivisions;

13. 19 VAC 30-70-440 is amended to reflect changes to service brakes, numerous subdivisions amended (consistent with the CFR);

14. 19 VAC 30-70-450 reflects changes to emergency, parking or holding brakes (consistent with changes to the CFR);

15. 19 VAC 30-70-460 is amended by adding reference to 19 VAC 30-70-450 dealing with emergency, parking or holding brakes (consistent with the CFR);

16. 19 VAC 30-70-470 is amended in numerous subdivisions reflecting changes to steering (consistent with the CFR);

17. 19 VAC 30-70-480 is amended reflecting changes to the suspension (consistent with the CFR);

18. 19 VAC 30-70-490 is amended to show changes to the frame, engine mounts, and coupling devices (consistent with the CFR);

19. 19 VAC 30-70-500 is amended to show changes to tires, wheels and rims (consistent with the CFR);

20. 19 VAC 30-70-550 is amended to show the minimum height for reflector placement (consistent with the CFR and § 46.2-1017 of the Code of Virginia);



21. 19 VAC 30-70-570 is amended to eliminate references to magneto or acetylene lighting, and subdivisions are renumbered;
22. 19 VAC 30-70-580 is amended to reflect changes in glazing (consistent with the CFR);
23. 19 VAC 30-70-680 is amended to reflect changes to the fuel system (consistent with the CFR).

Issues: The advantages of the changes in the proposed regulations are the enhancement to public safety and ensuring Virginia's compliance with the criteria as set forth in federal law, as noted above. There are no foreseeable disadvantages to the program, as each inspection station is already familiar with the inspection process and these changes would not impose a burden upon them.

There are no tangible advantages or disadvantages to the agency as a result of these modifications.

Department of Planning and Budget's Economic Impact Analysis: The Department of Planning and Budget (DPB) has analyzed the economic impact of this proposed regulation in accordance with § 9-6.14:7.1 G of the Administrative Process Act and Executive Order Number 13 (94). Section 9-6.14:7.1 G requires that such economic impact analyses include, but need not be limited to, the projected number of businesses or other entities to whom the regulation would apply, the identity of any localities and types of businesses or other entities particularly affected, the projected number of persons and employment positions to be affected, the projected costs to affected businesses or entities to implement or comply with the regulation, and the impact on the use and value of private property. The analysis presented below represents DPB's best estimate of these economic impacts.

Summary of the proposed regulation. The Virginia Official Inspection Manual provides guidelines for the annual inspection of all automobiles in the Commonwealth of Virginia. The proposed modifications are being made to comply with federal and state legislative changes. The opportunity is also being used to make several clarifications and eliminate references to obsolete terms.

Estimated economic impact. The Virginia Official Inspection Manual has been in effect for over 60 years. The proposed modifications are intended to insure Virginia's compliance with current federal and state legislation. Since each inspection station is already familiar with the inspection process, these changes impose no additional regulatory burden. According to the Virginia State Police (VSP), the proposed changes will not affect the length of an average inspection, currently 27 minutes, nor increase the number of vehicles rejected by more than a full percentage point. The number of vehicles currently rejected is between 10 and 11 percent.

The benefits resulting from clearer regulatory language and the enhancement of public safety will most likely outweigh any increases in consumer compliance costs. Although it would be difficult to measure the exact value of the benefits

and costs it can be expected that the proposed modifications will result in a relatively small, net economic gain.

Businesses and entities affected. These proposed modifications will affect all state inspection stations and owners of private and commercial vehicles. Since each inspection station is already familiar with the inspection process, these changes impose no additional regulatory burden. Automobile owners likewise are not expected to suffer any increased compliance costs. All citizens of Virginia will benefit from this enhancement of public safety.

Localities particularly affected. No locality will be particularly affected by the proposed changes to this regulation.

Projected impact on employment. The proposed changes to this regulation are not expected to have any impact on employment in Virginia.

Effects on the use and value of private property. The proposed changes to this regulation are not expected to have any effects on the use and value of private property.

Agency's Response to the Department of Planning and Budget's Economic Impact Analysis: The Department of State Police is in agreement with the economic impact analysis. The safety inspection process has occurred for over 60 years and no additional regulatory burden will be borne by the safety inspection stations, nor the general public.

#### Summary:

*The Virginia Official Inspection Manual provides guidelines for the annual inspection of all automobiles in the Commonwealth of Virginia. The proposed amendments are being made to comply with federal and state legislative changes. The opportunity is also being used to make several clarifications and eliminate references to obsolete terms.*

#### **19 VAC 30-70-5. Class III offenses.**

Class III offenses shall be violations of those sections of the Annual Motor Vehicle Inspection Manual considered most critical from a safety viewpoint. They would consist of the omission of checking or improper approval of an item so critical to the safe operation of a motor vehicle as to have the potential of being the imminent cause or factor of a motor vehicle crash. A violation of the following sections of the Annual Motor Vehicle Inspection Manual shall constitute a Class III offense unless designated otherwise:

- 19 VAC 30-70-10 J
- 19 VAC 30-70-10 P, P1, P2
- 19 VAC 30-70-80 in its entirety (except subdivision B 3)
- 19 VAC 30-70-90 in its entirety
- 19 VAC 30-70-100 in its entirety
- 19 VAC 30-70-110 in its entirety
- 19 VAC 30-70-120 in its entirety
- 19 VAC 30-70-130 in its entirety

---

# Proposed Regulations

---

- 19 VAC 30-70-140 in its entirety
- 19 VAC 30-70-160 I 10 h and 11 f
- 19 VAC 30-70-160 I 10 g and 11 g (2)
- 19 VAC 30-70-190 in its entirety
- 19 VAC 30-70-220 in its entirety
- 19 VAC 30-70-340 in its entirety
- 19 VAC 30-70-350 in its entirety
- 19 VAC 30-70-360 A and B
- 19 VAC 30-70-360 D 15 through D 22
- 19 VAC 30-70-370 in its entirety
- 19 VAC 30-70-400 in its entirety
- 19 VAC 30-70-440 in its entirety (except ~~subsection~~ *subdivision B 2*)
- 19 VAC 30-70-450 in its entirety
- 19 VAC 30-70-460 in its entirety
- 19 VAC 30-70-470 in its entirety
- 19 VAC 30-70-480 in its entirety
- 19 VAC 30-70-490 in its entirety
- 19 VAC 30-70-500 in its entirety
- 19 VAC 30-70-510 in its entirety
- 19 VAC 30-70-530 H 10 i and 11 g (2)
- 19 VAC 30-70-560 in its entirety
- 19 VAC 30-70-590 in its entirety

Disciplinary action for a Class III offense shall be:

1st offense - Written reprimand from the Safety Officer or his designee.

2nd offense - Suspension for not less than 45 nor more than 90 days.

Offenses are cumulative in nature and will remain active for a period of 24 months from date of offense.

A Class III offense in combination with two Class II offenses or three Class I offenses shall be grounds for no less than a 60-day nor more than 90-day suspension.

## **19 VAC 30-70-7. General information.**

Any violation under any class of offenses requiring a third suspension within a 24-month period shall be grounds for a revocation. The suspension or revocation period for a subsequent violation requiring suspension or revocation under any class of offenses within a 24-month period shall be twice that of a previous suspension or revocation.

For suspension periods of less than six months, inspection stations and safety inspectors will not be required to file application for reinstatement.

For suspension periods of six months or more, inspection stations and safety inspectors must complete the process as set forth for original appointment. Reapplications may be made 60 days prior to the suspension expiration. *Suspended inspectors shall contact the nearest safety office or supervising trooper to request reinstatement.*

Inspection stations and safety inspectors who have their privilege to perform inspections revoked, must complete the application process as set forth for original appointments after the expiration of the period of revocation.

## **19 VAC 30-70-10. Official inspection station requirements.**

A. Official inspection stations, except private appointments, shall be open at least eight hours of each normal business day, and shall be able to perform inspections 12 months throughout the year, except during illness of limited duration or normal vacation.

1. Normal business hours are defined as an eight-hour period of time between 8 a.m. and 6 p.m.

2. Stations are not prohibited from performing inspections at times other than during normal business hours.

3. A station which advertises inspections beyond normal business hours shall be able to perform such inspections.

4. If a station desires to maintain business hours which are different from those defined in this section, written permission must be obtained from the safety officer and a sign setting forth the inspection hours must be posted conspicuously at the station where it can be observed by a person desiring to have a vehicle inspected.

B. At least one safety inspector to perform inspections and one inspection lane, meeting the minimum requirements, shall be available for inspection at all times during the normal business day. All inspections must be made only at the locations and in the inspection lane approved by the Department of State Police.

The designated inspection areas, including any location where customers are permitted to enter when submitting vehicles for inspection, must be kept clean, free from excessive dirt, grease, and loose materials.

C. Inspection station facilities must be properly maintained and must present a businesslike appearance to the general public. Property adjacent to the inspection station which is owned or controlled by the station must be free of debris, litter, used parts and junk vehicles. Vehicles properly contained within fenced storage areas shall be deemed to comply with this requirement.

D. Inspections shall be performed on a first come, first serve basis. Motorists shall not be required to make an appointment to obtain an inspection, except that appointments required by paragraph 12 of the Governor's Proclamation, which appears at the end of this chapter, shall be made. Businesses that take in motorists' vehicles for

inspection at the beginning of the work day shall not be required to stop the work already taken in to provide an inspection for a drive-in motorist, provided inspections are actually being performed at the time and will continue through the day.

E. Safety inspectors, managers who supervise inspection activities and business owners through participation in the inspection program are representatives of the Department of State Police and should conduct themselves in a manner to avoid controversy in dealing with customers presenting vehicles for inspection. The use of profanity or verbal abuse directed at customers presenting their vehicles for inspection will be grounds for suspension from participation in the inspection program and will be considered a Class IV offense as set forth in 19 VAC 30-70-6 of the Guidelines for Administration of Virginia's Annual Motor Vehicle Inspection Program.

Controversy that cannot be calmly resolved by the safety inspector, managers, and owners should be referred to the supervising trooper for handling.

F. The "Certificate of Appointment" must be framed under glass and posted at or near the point of inspection where it can be observed and read by a person submitting a vehicle for inspection.

G. The required "Official Inspection Procedure" sheet furnished each station must be framed under glass and posted conspicuously where it can be observed and read by a person submitting a vehicle for inspection.

H. The poster designating the station as an official inspection station shall be posted in a prominent location, outside or visible outside the station to alert passersby that inspection services are available. Private inspection stations need not comply with this section.

I. Each official inspection station shall display a list with the name(s) and license expiration date of all employees licensed to inspect at that station adjacent to the appointment certificate, where it can be observed by a person submitting a vehicle for inspection.

The official inspection manual will be kept at or near the point of inspection for ready reference.

J. Important - Any change in name, ownership or location of any official inspection station cancels the appointment of that station and the Department of State Police must be notified immediately. The department shall be notified when an official inspection station discontinues operation.

K. All inspection supplies, inspection binders and manual, unused stickers, duplicates of certificates issued, bulletins, and other forms are the property of the Department of State Police and must be safeguarded against loss.

L. Inspection supplies issued to an inspection station can be used only by that station and are not to be loaned or reissued to any other station with the exception of inserts.

1. Stations must maintain a sufficient supply of approval stickers, T/M decals and rejection stickers.

2. Inspection stations that exhaust their supply of approval stickers, rejection stickers or T/M decals, shall immediately stop performing new inspections and contact their supervising trooper or the nearest Safety Division office.

M. All losses of stickers must be reported orally at once to the nearest State Police area safety office or supervising inspection trooper.

N. Every precaution against the loss of stickers must be taken. If the loss occurs through carelessness or neglect, a suspension of the station may result.

O. Manuals, bulletins, other regulations and lists of approved equipment must be available at all times for reference. Revisions to the inspection manual must be inserted in the manual at the proper location promptly after being received by the inspection station. Bulletins of temporary interest and pages of bulletins containing the synopsis of manual revisions will be retained in the front of each station's inspection manual for two years. Each safety inspector shall review the material contained in each inspection bulletin and manual revision within 15 days of its receipt. The safety inspector shall certify that the revisions have been reviewed by signing his/her name and placing the date reviewed by the signature on the bottom or reverse side of the bulletin or manual revision cover sheet. Station management shall be responsible to see that each safety inspector is familiar with all bulletins and manual revisions and shall be required to furnish evidence to the department that all bulletins and manual revisions have been reviewed by each licensed inspector.

A copy of the diagram drawn by the investigating trooper, showing the approved inspection lane or lanes will be inserted in a plastic page protector and inserted as the last page of the official inspection manual at each official inspection station. The name of the station and the date will be inserted in the top right corner.

P. Private appointment may be made of company stations or government stations who own and operate a minimum of 20 vehicles and they may inspect only company-owned or government-owned vehicles respectively. When authorized by the department, they may inspect vehicles of a wholly owned subsidiary or leased vehicles.

1. A private station may perform inspections during each month of the year or may elect to inspect only during certain designated months.

2. A private station not electing to inspect vehicles every month of the year which finds it necessary to inspect a vehicle during a month other than those selected for inspection may issue a sticker to the vehicle from the nearest past inspection month.

Q. All official inspection station owners, operators and certified safety inspectors shall comply with the Virginia inspection laws and the inspection rules and regulations. Reports of violations will be investigated and if found to be valid may result in the suspension of the station, suspension of the mechanic, possible court action or other appropriate

---

# Proposed Regulations

---

action. Repeated violations or serious violations may result in a revocation of the station appointment by the Superintendent.

R. The arrest of any person associated with the inspection program for a criminal offense of a nature which would tend to immediately reflect upon the integrity and reputation of the Department of State Police shall be grounds for an immediate suspension and the conviction for such an offense may result in a revocation of the station appointment.

S. When a station has been suspended or revoked, it must release to a member of the Department of State Police all inspection supplies, posters, and papers including the certificate of appointment. Failure to do so is a violation of § 46.2-1172 of the Code of Virginia.

T. The authority of the Superintendent to suspend the designation or appointment of an official inspection station as provided in § 46.2-1163 of the Code of Virginia, or to suspend the certification of a mechanic designated to perform inspections at an official inspection station in keeping with the provisions of § 46.2-1166 of the Code of Virginia, is hereby delegated to any of the following supervisory ranks of the Department of State Police: "Lieutenant Colonel, Major, Captain, Lieutenant and, First Sergeant and Sergeant."

## 19 VAC 30-70-50. Approval stickers and decals.

A. If the vehicle meets all inspection requirements, the inspection sticker receipt shall be legibly filled out with a ball point pen in its entirety and signed by the authorized mechanic making the inspection. The inspection fee, the cost of the repairs relating to the inspection and the identification number must be included.

B. Approval stickers and decals shall be issued according to the following schedule:

### ANNUAL PROGRAM

Vehicles inspected in January	issued stickers bearing the Number "1"
Vehicles inspected in February	issued stickers bearing the Number "2"
Vehicles inspected in March	issued stickers bearing the Number "3"
Vehicles inspected in April	issued stickers bearing the Number "4"
Vehicles inspected in May	issued stickers bearing the Number "5"
Vehicles inspected in June	issued stickers bearing the Number "6"
Vehicles inspected in July	issued stickers bearing the Number "7"

Vehicles inspected in August issued stickers bearing the Number "8"

Vehicles inspected in September issued stickers bearing the Number "9"

Vehicles inspected in October issued stickers bearing the Number "10"

Vehicles inspected in November issued stickers bearing the Number "11"

Vehicles inspected in December issued stickers bearing the Number "12"

All February annual inspection stickers and trailer/motorcycle decals (#2) due to expire at midnight, February 28 automatically will be valid through midnight February 29 each leap year.

C. The numeral decal indicating the month of expiration shall be inserted in the box identified as month and the numeral decal indicating the year of expiration shall be inserted in the box identified as year of the approval sticker and the trailer/cycle decal. Extreme care should be used by inspectors in applying these inserts. On all windshields, except school buses, the sticker is to be placed at the bottom of the windshield so that the inside or left edge of the sticker is one inch to the right of the vertical center of the windshield when looking through the windshield from inside the vehicle. (If the vehicle is normally operated from the right side, the sticker must be placed one inch to the left of the vertical center of the windshield.) On passenger vehicles not equipped with a windshield, the sticker shall be placed on or under the dash and protected in some manner from the weather.

The approval sticker on official yellow school buses is to be placed at the bottom and in the right corner of the windshield when looking through the windshield from inside the vehicle.

EXCEPTION: The approval sticker shall be placed one inch to the right of the vertical center of the windshield when looking through the windshield from the inside on all new flat-face cowl yellow school buses.

Stickers or decals used by counties, cities and towns in lieu of license plates affixed adjacent to the old approval sticker and which are affixed in the location where the new approval sticker is required to be placed will not be removed. In these cases, the approval sticker will be placed as close to one inch to the right of the vertical center of the windshield as it can be placed without removing or overlapping the county, city or town decal.

D. The Virginia statutes require that the inspection sticker be displayed on the windshield or at other designated places at all times. The inspection sticker cannot be transferred from one vehicle to another.

EXCEPTION: If the windshield in a vehicle is replaced, a valid sticker may be removed from the old windshield and placed on the new windshield.

E. The decal issued to a motorcycle shall be affixed to the front left side of the cycle on a flat surface or left front shock where it will be visible after mounting.

F. Trailer decals will be issued to all trailers and semitrailers required to be inspected. (No boat, utility, or travel trailer which is not equipped with brakes shall be required to be inspected.)

G. All trailers must display a trailer decal on that particular vehicle. These decals are to be placed on the left side of the trailer near the front corner. The decal must be affixed to the trailer body or frame. In those instances where a metal back container with a removable transparent cover has been permanently affixed to the trailer body, the decal may be glued to it. The container must be permanently mounted in such a manner that the decal must be destroyed to remove it.

H. In all other cases involving unusually designed trailers such as pole trailers, the inspecting mechanic is to exercise his own good judgment in placing the decal at a point where it will be as prominent as possible and visible for examination.

I. Decals shall be punched to indicate whether issued to a motorcycle or trailer. (The type vehicle being inspected shall be punched.)

The receipts are completed in the same manner as other inspection receipts.

J. Appointed stations will keep sufficient inspection supplies on hand to meet their needs. Requests for additional supplies are to be made to the Safety Division by telephone or in writing. *Requests for supplies that are to be picked up at the Safety Division headquarters must be made at least 24 hours prior to pick up.*

1. Do not make requests for stickers on inventory forms or slips of paper enclosed with returned supplies.
2. Packing slips mailed with inspection supplies will be kept on file at the station for at least 24 months.

K. All unused center inserts used to indicate the month that a sticker or decal expires, in possession of the inspection station at the end of each month shall be retained by the inspection station, properly safeguarded, and used in the inspection of vehicles for the particular month in the following year or be disposed of as directed by the Department of State Police.

All inspection supplies that are voided, damaged, disfigured or become unserviceable in any manner, will be returned to the Safety Division, Department of State Police and replacement supplies will be furnished the station. Expired stickers will be picked up by the station's supervising trooper.

L. The white receipts shall be left in completely used books of approval stickers and decals. Used white receipts

shall be removed from all partly used books of approval stickers and decals at the end of each month *and placed in numerical order*. All receipts will be forwarded to the Safety Division by the fifth of the month following the month of inspection. All voided approval stickers and decals shall be marked void and returned with the white receipts.

M. The pink receipt copies of the approval stickers and decals shall be given to the owner or operator of the vehicle.

N. All yellow receipt copies of approval stickers and decals shall be kept on file at the station for at least 24 months. They may be inspected by any law-enforcement officer during normal business hours.

O. Safety Division troopers may replace inspection stickers that have separated from the windshield of motor vehicles and become lost or damaged without conducting an inspection of the safety components of the vehicle. Such replacement of inspection stickers shall be made only in accordance with the following provisions:

1. A vehicle owner or operator complaining of the loss or damage to the inspection sticker on the windshield of their vehicle due to separation of the sticker from the windshield shall be directed to the nearest Safety Division office or Safety Division trooper.
2. Safety Division troopers, upon receipt of a complaint from a vehicle owner or operator that their inspection sticker has been stolen, lost or become damaged due to separation from the windshield will make arrangements to meet the person to effect the replacement of the sticker. A vehicle owner or operator alleging theft of the inspection sticker will furnish proof to the Safety Division trooper that such theft has been reported to proper law-enforcement authority.
3. The vehicle owner or operator must produce the original pink inspection receipt indicating a valid approval inspection sticker was issued to the vehicle within the past 11 months. (The vehicle must be reinspected if the expiration of the original inspection sticker is in the month the request is being made.)
4. The Safety Division trooper will verify by the inspection receipt that the vehicle was issued an approval inspection sticker within the past 11 months and issue a replacement inspection sticker to the vehicle.
5. The Safety Division trooper will complete the inspection sticker receipt for the approval sticker from information contained on the original receipt. The date the replacement sticker is issued will be used in the date space. In the space for "Inspection Related Charges," the trooper will insert the word "REPLACEMENT" and the sticker number from the original pink inspection receipt.
6. The Safety Division trooper will sign the receipt vertically in the O.K. column in the "Equipment Inspected" blocks. These blocks will not otherwise be completed.

---

# Proposed Regulations

---

7. The Safety Division trooper shall place month and year inserts on the inspection sticker to reflect the expiration as shown on the original approval inspection sticker and place the inspection sticker on the windshield in accordance with the requirements of subsection C of this section.

8. The Safety Division trooper will staple the original pink inspection receipt to the new white receipt. At the end of each week, the Safety Division trooper will forward all inspection receipts for replacement stickers issued by him to the Safety Division. The yellow receipts will be submitted to the area office and maintained on file for 24 months.

## 19 VAC 30-70-70. Inventory.

A. Each inspection station at the end of each quarter, shall fill in the applicable portion of an inspection sticker inventory report (Form SP-221) in duplicate on stickers, trailer/motorcycle decals and rejection stickers used. This report shall be completed by the fifth of April, July, October and January for the preceding quarter and shall be kept on file at the station.

1. At the end of the calendar quarter the monthly totals will be combined into a quarterly total reflecting total number of stickers, trailer/motorcycle decals, rejection stickers and voided stickers used during the quarter. All approval stickers, trailer/motorcycle decals and rejection stickers unused and on hand at the end of the quarter shall be listed in the space provided on ~~the back of~~ the inventory report (Form SP-221-).

2. The inventory report after its completion shall be retained at the inspection station until it is reviewed and picked up by the station's supervising trooper during his supervisory visit. The other copy of the inventory report shall be retained by the station for at least 24 months.

B. The calendar quarterly inventory reports shall be completed according to the following schedule:

Quarter of Year	Months of
1st	January, February, March
2nd	April, May, June
3rd	July, August, September
4th	October, November, December

## 19 VAC 30-70-80. Service brakes.

A. The inspector, as a minimum, must drive all vehicles into the inspection lane and test both service and parking brakes.

B. A minimum of two wheels or two wheels and drums, one front and one rear, must be removed from each passenger and multi-purpose vehicle with a gross vehicle weight rating of 10,000 pounds or less at the time of inspection, except those listed in subdivisions 1, 2 and 3 below. Two front wheels or two front wheels and drums must be removed from vehicles listed in subdivision 3 below.

1. Motorcycles.

2. A new model vehicle, is defined as a vehicle that has not been titled or leased and is less than one year old, measured from October 1 as of each year; or if such motor vehicle does not have a model year, such measurement shall be made from the date of manufacture.

3. Trucks with floating axles that require seal replacement upon removal of rear wheels. The inspection receipt (approval and rejection) shall be marked to reflect which wheels were pulled.

Warning: Lug nuts must be torqued to the manufacturer's specifications to prevent damage to disc rotors. The use of an impact wrench may exceed the manufacturer's specifications and damage disc rotors.

C. If any braking problem is detected, the inspector may test drive or require a test drive of the vehicle ~~and use the decelerometer as necessary. If the decelerometer is used and the vehicle does not meet the minimum standards for stopping distances as shown in subdivision F11 of this section, the vehicle shall be rejected.~~

D. Inspect for and reject if:

1. Vehicle is not equipped with brakes, or any brake has been disconnected, rendered inoperative, or improperly installed. Trailers having an actual gross weight of less than 3,000 pounds are not required to be equipped with brakes; however, if brakes are installed, these vehicles must be inspected.

### Brake System Failure Indicator Lamp

2. Passenger vehicles manufactured after January 1, 1968, are not equipped with a brake failure warning lamp or warning lamp does not light with parking brake applied when ignition key is turned to the start position, except for anti-lock system. With engine running and parking brake released, the lamp should go off, except for vehicles equipped with anti-lock system. Apply service brake for 10 seconds. If the brake warning lamp lights again, the warning light does not come on when there is a leak, or the light is not functioning properly, the system is defective. NOTE: This paragraph does not apply to vehicles registered as street rods.

### Brake Linings and Disc Pads

3. Riveted linings or disc pads are worn to less than 2/32 of an inch over the rivet head(s).

4. Bonded or molded linings or disc pads are worn to less than 2/32 of an inch in thickness or are worn beyond manufacturer's specifications.

5. Wire in wire-backed lining is visible in friction surface.

6. Snap-on brake linings are loose.

7. Any lining is broken or cracked so that lining or parts of lining are not firmly attached to the shoe or has cracks on the friction surface extending to the open edge.

8. Grease or other contamination cannot be satisfactorily removed from the lining, drums, or rotors.
9. Rivets in riveted linings are loose or missing.
10. Any lining or pad is misaligned or does not make full contact with the drum or rotor.

### Brake Drums and Discs

11. Brake drums or brake discs (rotors) are worn or scored to the extent that their remachining would ~~exceed~~ result in a failure to meet manufacturer's specifications.
12. Brake drums or discs have any external crack or cracks more than one half the width of the friction surface of the drum or disc. NOTE: Do not confuse short hairline heat cracks with flexural cracks.

### Mechanical Linkage

13. Cables are frayed or frozen.
14. Mechanical parts missing, broken, badly worn, or misaligned.

### E. Hydraulic.

NOTE: Some motor vehicles, beginning with 1976 models, have a hydraulic power system that serves both the power assisted brakes and power assisted steering system. Some vehicles, beginning with 1985 models, have an integrated hydraulic actuation and anti-lock brake unit using only brake fluid.

1. Brake hydraulic system. Inspector should check the brake hydraulic system in the following manner: test vehicle in a standing position; apply moderate pressure to the brake pedal for 10 seconds. Brake pedal height must be maintained. On vehicles equipped with power assisted systems, the engine should be running.
2. Hydraulic system operation. Stop engine, then depress brake pedal several times to eliminate all pressure. Depress pedal with a light foot-force (30 pounds). While maintaining this force on the pedal, start engine and observe if pedal moves slightly when engine starts.

Reject vehicle if pedal does not move slightly as engine is started while force is on brake pedal.

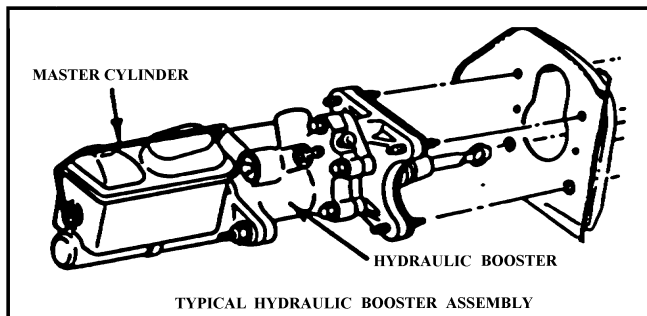

3. Condition of hydraulic booster power brake system. Inspect system for fluid level and leaks.

Reject vehicle if there is insufficient fluid in the reservoir; if there are broken, kinked or restricted fluid lines or hoses; if there is any leakage of fluid at the pump, steering gear or brake booster, or any of the lines or hoses in the system; or if belts are frayed, cracked or excessively worn.

4. Integrated hydraulic booster/anti-lock system operation. With the ignition key in the off position, depress brake pedal a minimum of 25 times to deplete all residual stored pressure in the accumulator. Depress pedal with a light foot-force (25 pounds). Place ignition key in the on position and allow 60 seconds for the brake warning light to go out and the electric pump to shut off.

Reject vehicle if the brake pedal does not move down slightly as the pump builds pressure or if the brake and anti-lock warning lights remain on longer than 60 seconds.

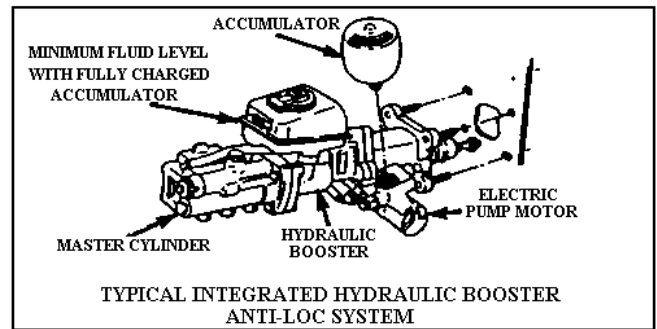

5. Condition of integrated hydraulic booster/anti-lock system with electronic pump. With the system fully charged, inspect system for fluid level and leaks.

Reject vehicle if there is insufficient fluid in the reservoir; if there are broken, kinked or restricted fluid lines or hoses; or if there is any leakage of fluid at the pump or brake booster, or any of the lines or hoses in the system.

6. Vacuum system operation. Stop engine then depress brake pedal several times to eliminate all vacuum in the system. Depress pedal with a light foot-force (25 pounds). While maintaining this force on the pedal, start engine and observe if pedal moves down slightly when engine starts.

Reject vehicle if pedal does not move down slightly as engine is started while force is on the brake pedal. In full vacuum-equipped vehicles, there is insufficient vacuum reserve for one full service brake application after engine is stopped.

# Proposed Regulations

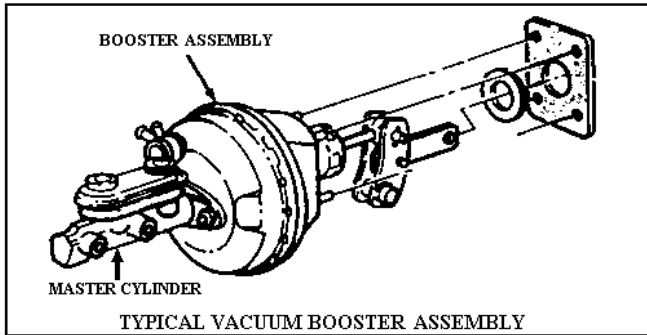

7. Condition of vacuum booster power brake system. Reject vehicle if there are collapsed, cracked, broken, badly chafed or improperly supported hoses and tubes, loose or broken hose clamps.

F. Inspect for and reject if:

### General Specifications - Hydraulic Brakes

1. There is any leakage in the master cylinder, wheel cylinders, or brake calipers. (Do not disturb the dust boot when checking for leaking wheel cylinders.)
2. Fluid level in master cylinder is below the proper level for the particular vehicle.
3. There is any evidence of a caliper sticking or binding.

### Electric Brake System

4. Trailers show an amperage value more than 20% above or 30% below the brake manufacturer's maximum current rating for each brake.
5. Ammeter shows no reading or indicator is not steady on application and release of brake controller.
6. Any terminal connections are loose or dirty; wires are broken, frayed, or unsupported; any single conductor or nonstranded wire or wires below size recommended by brake manufacturers are installed.
7. Electrical trailer brakes do not apply automatically when breakaway safety switch is operated.

### General Specifications

8. There is any leakage in any hydraulic, air, or vacuum lines; hoses have any cracks, crimps, restrictions, or are abraded exposing fabric; tubing or connections leak, are crimped, restricted, cracked or broken; any valves leak or are inoperative.

Reject the vehicle if the brake hoses or lines are stretched or extended and do not allow for suspension movement.

9. Brakes are not equalized so as to stop the vehicle on a straight line.

10. There is less than 1/5 reserve in actuator travel of the service brake when fully applied on all hydraulic, mechanical, or power-assisted hydraulic braking systems.

11. When tested on dry, hard, approximately level road free from loose material, at a speed of 20 miles per hour without leaving a 12-foot wide lane, a brake machine or decelerometer reading results in excess of the following distances is obtained: (When in doubt about a vehicle's stopping ability, the inspector shall conduct a road test.)

- a. Any motor vehicle (except motorcycles, trucks, and tractor-trucks with semitrailers attached) four wheel brakes—25 feet.
- b. Any motor vehicle (except motorcycles, trucks, and tractor-trucks with semitrailers attached) two wheel brakes—45 feet.
- c. All combinations of vehicles—40 feet.

### 19 VAC 30-70-90. Brakes: emergency, parking, or holding.

Some vehicles are equipped with an actual emergency brake, while others have only a parking or holding brake. Some types may be actuated by a foot or hand lever, while others may incorporate a switch or valve to actuate the brake. Air and vacuum brake systems may employ spring activating parking brakes.

Inspect for and reject if:

1. Vehicle or combination of vehicles is not equipped with a parking, holding, or emergency brake in good working order of the type installed as original standard factory equipment for the vehicle on which it is installed.
2. The parking brake actuating mechanism does not fully release when the control is operated to the off position.
3. Any mechanical parts are missing, broken, badly worn, or are inoperative.
4. Cables are stretched, worn, or frayed or not operating freely.
5. Parking brake will not hold the vehicle stationary with the engine running at slightly accelerated speed with shift lever in drive position for automatic transmission or shift lever in low gear with clutch engaged for standard shift transmission.
6. *Holding brake will not disengage when engine is started and vehicle is placed in drive. Holding brake will not hold vehicle stationary with foot on holding brake and vehicle in drive.*
7. On vehicles equipped with automatic transmissions, the vehicle will start in any gear other than (P) park and (N) neutral.

7- 8. Passenger vehicles manufactured after January 1, 1968, are not equipped with a brake failure warning lamp or warning lamp does not light with parking brake applied when ignition key is turned to the start position, except for anti-lock system. With engine running and parking brake released, the lamp should go off, except for vehicles equipped with anti-lock system. Apply



service brake for 10 seconds. If the brake warning lamp lights again, the warning light does not come on when there is a leak, or the light is not functioning properly, the system is defective. NOTE: This paragraph does not apply to vehicles registered as street rods.

**19 VAC 30-70-100. Brakes: trailer (GVWR less than 10,000 pounds).**

Inspect for and reject if:

1. Trailer brakes do not comply with 19 VAC 30-70-80 and 19 VAC 30-70-90.
2. Operator does not have full control over brakes.
- ~~3. Combination will not stop as required in 19 VAC 30-70-80 F 11 e.~~

4. 3. All trailers, manufactured or assembled after January 1, 1964, registered for an actual gross weight of 3,000 pounds or more are not equipped with emergency breakaway brakes designed to:

- a. Apply automatically upon breakaway from towing vehicle.
- b. Remain fully applied for at least 15 minutes.
- c. Apply and release by operation of the manual emergency control.

~~5.~~ 4. A minimum of one wheel must be removed from each axle equipped with brakes to inspect the brake components.

NOTE: Trailers registered for an actual gross weight of 3,000 pounds or more, but with a manufacturer's gross weight rating of less than 10,000 pounds need not be equipped with brakes on all wheels.

- a. Exception: Wheels on trailers equipped with open brake mechanisms are not required to be removed.
- b. The inspection receipt approval and rejection shall be marked to reflect on which side the wheel or wheels were pulled.

**19 VAC 30-70-140. Headlamps; except motorcycles.**

A. Inspect for and reject if:

1. Any motor vehicle is not equipped with headlamps of an approved type.
2. Headlights are not of the same approved type except sealed beam headlamps. At least two headlamps are required.
3. In any headlamp the lens is cracked, broken, discolored, or rotated away from the proper position, or the reflector is not clean and bright.
4. Moisture or water buildup in headlamp is such that it affects the aimable pattern.
5. Lens is other than clear.

6. Bulbs are not of an approved type or are over 32 candlepower. (Sealed beam lamps including the ones which permit the use of a replacement halogen bulb are the only lamps approved with over 32 candlepower.) Ordinary lenses and reflectors were not designed for over 32 candlepower bulbs.

7. Any filament or bulb in headlamps fails to burn properly or headlamps are not at the same location or configuration as designed by manufacturer. (Location and type of headlamps can be found in subsection E of this section.)

8. Wiring is dangling or connections are loose, or if proper filaments do not burn at different switch positions, or if switches-including foot or hand dimmer-do not function properly, and are not convenient to the driver.

9. Foreign material is placed on or in front of the headlamp lens or interferes with the beam from the lamp. No glazing may be placed over or in front of the headlamps unless it is a part of an approved headlamp assembly.

a. Reject if vehicle has wire, unapproved plastic covers, any other materials which are not original equipment or any colored material placed on or in front of the headlamps.

b. Vehicles registered as street rods may have clear, rigid plastic or glass headlamp lens covers in front of sealed beam units to replace original manufacturer's equipment.

10. Lamps can be moved easily by hand due to a broken fender or loose support, or if a good ground is not made by the mounting.

11. A headlamp visor is over two inches long unless part of the original body design.

12. The high beam indicator in the driver's compartment does not burn when the high or "country" beam is on or does not go off when the low beam is on. (Vehicles not originally equipped with an indicator are not required to comply unless sealed beam headlamps have been installed.)

B. Aiming the headlamps.

1. Headlamps shall be checked for proper aim by using either an optical or a mechanical headlamp aimer on every motor vehicle inspected, except vehicles with on-board aimers.

Headlamp aim on vehicles with on-board aimers shall be checked by visually examining the leveling device mounted either on or adjacent to the headlamp. Reject the vehicle if the leveling device shows the headlamp adjustment to exceed indicated specifications.

NOTE: Driving lamp and fog lamps must be aimed using the optical ~~or mechanical~~ aimer, according to instructions in 19 VAC 30-70-160 I 10 i and 11 g (2).

# Proposed Regulations

2. Headlamps are not aimed within the following tolerances using the optical aimer.

a. The center of the hot spot of all single element high beam lamps is set more than four inches up or down from the horizontal centerline or more than four inches to the left or right from the vertical centerline.

b. The left edge of the lamp pattern of any low beam lamp or any combination or multi-element lamp is more than four inches to the left or right of the vertical centerline or the top edge of the lamp pattern is more than four inches above or below the horizontal centerline when checked on low beam.

C. Optical aimer.

1. Approved optical headlamp machines may be used to properly aim any of the headlamps. Optical aimers must be properly calibrated and used in the manner recommended by the manufacturer.

The optical headlamp machine must be aligned to the vehicle in accordance with the manufacturer's specifications.

2. When aiming headlamps, first look for the type of lamp, which will be found embossed on the lens. The type determines which aiming requirements must be followed for the optical aimer.

3. All low beam or combination/multi-element headlamps must be set by aiming the lamp pattern with the lamps set on low beam.

4. Pattern should be aimed so that the left edge does not extend to the left or right of straight ahead, and the top of the pattern should be even with the horizontal.

Pattern "A" represents the light pattern as it should appear on the view screen of the approved aimer.

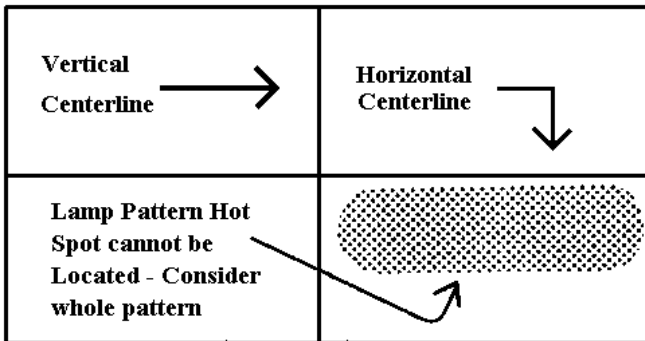

**PATTERN A - COMBINATION MULTI-ELEMENT OR LOW BEAM LAMP**

5. All single element high beam headlamps shall be set by aiming the center of the hot spot with the lamps set on high beam.

6. Aim straight ahead-center of the hot spot should be centered with the vertical and horizontal centerlines.

Pattern "B" represents the light pattern as it should appear on the view screen of the approved aimers.

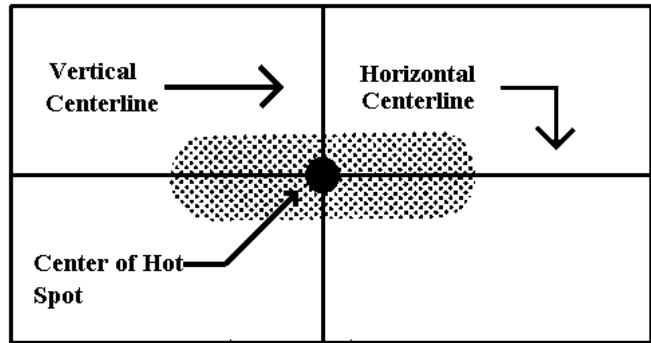

**PATTERN B - SINGLE ELEMENT HIGH BEAM LAMP**

7. When lamp pairs are mounted horizontally, the low beam lamp must be on the outer side and when mounted vertically, the low beam lamp must be at the higher position in the pair.

8. The four headlamp system must be wired so that only the lower beam lamp will burn when the light beams are depressed. When switched to high beams, both high beam and low beam may burn.

The "F" type halogen headlamp 1986 (LF-UF) of the four headlamp system will function in the following manner: system must be used so the low beam does not burn with the high beam.

D. Mechanical aimers.

1. Mechanical aimers can be used to aim only those headlamps that have "aiming" pads molded into the lens.

2. Mechanical aimers must be properly calibrated and used with the proper adapter recommended by the manufacturer. (The adapter setting will be embossed on the face of some lamps.)

3. Turn on headlamps and check all filaments-both high and low beam. Turn off headlamps before checking for adjustments. Do not turn on headlamps while mechanical aimers are attached to the headlamp.

4. All headlamps that are found not to be within the four-inch tolerance shall be adjusted to zero inches up or down and zero inches to the right or left.

E. Headlamps on vehicles used for snow removal. Approved auxiliary headlamps may be mounted above the conventional headlamps. (These lamps must be in compliance with this section in its entirety, subdivision 7 of 19 VAC 30-70-150, and subdivision 1 of 19 VAC 30-70-170.)

Inspect for and reject if:

1. Lamps are not approved type headlamps.
2. Lamps are not mounted in a manner which will permit proper aiming.

3. Lamps are mounted so as to obstruct the driver's vision.
4. The auxiliary headlamp circuit does not contain a switch which will deactivate the primary headlamp system when the auxiliary headlamps are in use.
5. Auxiliary headlamps are not aimed in accordance with the provisions of subdivision B 2 of this section.
6. Headlamps are not wired in accordance with the provisions of subdivision C 8 of this section.

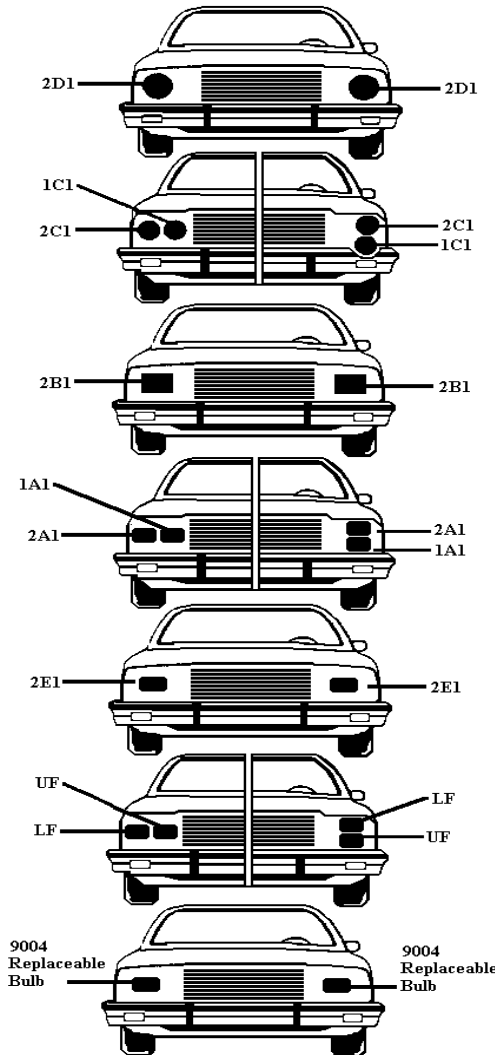

**Locations of Type 1, Type2, LF/UF, and Replaceable Bulb Headlamps**

NOTE: Always inspect the following sealed beam and replaceable bulb, and integral beam headlamps on LOW BEAM only;

- 5¾ inch, marked 2, 2C, or 2C1
- 7 inch, marked 2, 2D, or 2D1
- 100 x 165mm rectangular, marked 2A, 2A1, or 2E1, 2G1 or 2H1

- 200 x 142mm rectangular, marked 2B or 2B1
- Replaceable bulb headlamp, marked LF with 9004 (HB1)
- 92 x 160mm rectangular, marked LF
- Replaceable bulb headlamps with 9006 (HB4) alone or in combination with 9005 (HB3)
- 55 x 135mm rectangular, marked L
- Integral beam headlamp when high and low beam reflectors move together.

## 19 VAC 30-70-160. Auxiliary lamps: backup; cornering; driving; fog; spot and warning.

A. Auxiliary lamps on a vehicle consist of seven general types: backup lamps, cornering lamps, driving lamps, fog lamps with an amber or clear lens, spot lamps and warning lamps, and daytime running lamps.

B. School buses may be equipped with an eight-lamp warning system of two red and two amber warning lamps of an approved type on the front and rear of such vehicle.

1. School buses may also be equipped with roof mounted flashing white or amber warning lamps of an approved type.

2. In addition to required warning lamps, school buses may be equipped with a stop signal arm consisting of an octagonal sign which meets FMVSS specifications (Federal Motor Vehicle Safety Standards, 49 CFR 571 et seq.). The stop signal arm shall be reflectorized or be equipped with two red warning lamps of an approved type.

C. There is no limit on the number of backup lamps that a vehicle may have so long as they are of an approved type.

D. No more than four lamps, including two headlamps, may be lighted at any time to provide general illumination ahead of the vehicle.

E. Approved type blue or blue and red lights are permitted on any law-enforcement vehicle. Approved type red warning lights or red and white lights showing to the front are permitted on fire department vehicles, including publicly owned state forest warden vehicles, ambulances, any rescue vehicle used for emergency calls, animal warden vehicles, school buses and vehicles used by security personnel at the Newport News Shipbuilding and Drydock Company, Bassett-Walker, Incorporated, or the Tultex Corporation. No more than two flashing or steady-burning red lights or red and white combination lights of an approved type may be installed on one vehicle owned by any member of a fire company, volunteer fire company or volunteer rescue squad.

F. Vehicles mentioned in subsection E of this section permitted to be equipped with flashing, blinking or alternating red, red and white, blue, or blue and red emergency lights (except vehicles owned by any member of a fire company, volunteer fire company, volunteer rescue squad or any ambulance driver employed by a privately owned ambulance

---

# Proposed Regulations

---

service) may be equipped with the means to flash their headlamps when their emergency warning lamps are activated provided:

1. The headlamps are wired to allow either the upper beam or lower beam to flash but not both; and
2. The headlamp system includes a switch or device which prevents flashing of headlamps when headlamps are required to be lighted pursuant to current statute.

G. Any fire vehicle used exclusively for fire fighting, any ambulance or rescue or lifesaving vehicle used for the principal purpose of emergency relief or any wrecker used for the principal purpose of towing disabled vehicles may be equipped with clear auxiliary lamps which shall be used exclusively for lighting emergency scenes. Such lamps shall be of a type permitted by the superintendent. Any government-owned police vehicle may be equipped with clear auxiliary lamps of a type approved by the superintendent.

H. Approved type amber flashing, blinking or alternating lights are permitted on vehicles used for the principal purpose of towing or servicing disabled vehicles or in constructing, maintaining and repairing highways or utilities on or along public highways and vehicles used for the principal purpose of removing hazardous or polluting substances from the state waters or drainage areas on or along public highways. Such lamps are permitted on vehicles used for servicing automatic teller machines, refuse collection vehicles, hi-rail vehicles and on vehicles used for towing or escorting over-dimensional materials, equipment, boats, or manufactured housing units by authority of highway hauling permit.

1. Approved type amber flashing, blinking or alternating lights are permitted on fire apparatus, ambulances, and rescue and life-saving vehicles, provided the amber lights are mounted or installed on the rear of the vehicles.
2. Approved type amber flashing, blinking or alternating lights are permitted on vehicles owned and used by businesses providing security services and vehicles used to collect and deliver the United States mail, vehicles used by law enforcement personnel in the enforcement of laws governing motor vehicle parking, government owned law enforcement vehicles provided the lights are used for giving directional warning and vehicles used to provide escort for funeral processions.
3. An approved type amber flashing, blinking or alternating light may be mounted on the rear of any vehicle used to transport petroleum products. The light must be wired through the reverse gear circuit and activate in conjunction with the back-up lights and audible alarm.

I. Inspect for and reject if:

1. Vehicle has an auxiliary lamp being used for a purpose other than for which it was approved;

EXCEPTION: Any lighting device ~~mounted above the level of the regular headlamps~~ which is both covered and not illuminated, other than lamps required, shall not be considered for inspection. Fog and driving lamps mounted below the level of the regular headlamps must be checked for aim as outlined in subdivisions I 10 i and 11 g of this section *if not covered*.

2. A vehicle has installed on it a warning lamp that is not of an approved type or has been altered.

Reject if the vehicle has wire, unapproved plastic covers, any other materials which are not original equipment or any colored material placed on or in front of any auxiliary lamps: backup, cornering, driving, fog, spot, or warning lamps.

3. Vehicle is equipped with a combination of auxiliary lamps which include more than two fog lamps, or more than two spot lamps, or more than two driving lamps. Reject a vehicle equipped with a headlamp mounted or used as an auxiliary lamp.

NOTE: Vehicles equipped, from the factory, with two driving lamps should not be rejected.

4. Vehicle is equipped with an auxiliary lamp that does not function properly. (If an auxiliary lamp has been modified by removing the wiring, bulb and socket, the unit will be considered an ornament and not a lamp and will not be considered in inspection.)
5. Vehicle is equipped with a lighted advertising sign. Except commercial motor vehicles, buses operated as public carriers, taxicabs, and privately-owned passenger cars used for home delivery of commercially prepared food. Commercial motor vehicles, buses operated as public carriers, and taxicabs may be equipped with vacant and destination signs and one steady burning white light for illumination of external advertising. Privately-owned passenger cars used for home delivery of commercially prepared food may be equipped with one steady burning white light for the nighttime illumination of a sign identifying the business delivering the food. Do not reject approved identification lights.
6. Any lamp is not of an approved type or if lamps to be burned together as a pair do not emit the same color light.
7. The lens has a piece broken from it. The lens may have one or more cracks provided an off-color light does not project through the crack or cracks.
8. Backup lamps are not required. However, if installed they must operate and be inspected.

Inspect for and reject if:

- a. Lamps are not of an approved type or a lamp has been altered;
- b. Wiring or electrical connections are defective;

c. The lens has a piece broken from it. The lens may have one or more cracks provided in off-color light does not project through the crack or cracks;

d. Lens is other than clear;

e. Lamps are not wired into the reverse gear or an independent circuit;

9. Cornering lamps are not required. However, if installed they must operate and be inspected.

Inspect for and reject if:

a. Lamps are not of an approved type or a lamp has been altered;

b. Wiring or electrical connections are defective;

c. The lens has a piece broken from it. The lens may have one or more cracks provided an off-color light does not project through the crack or cracks;

d. The color of the light is other than clear or amber;

e. The lamps do not burn in conjunction with the turn signals;

10. Driving lamps are not required. However, if installed they must operate and be inspected.

Inspect for and reject if:

a. Driving lamps are installed on vehicles equipped with the four headlamp system, except the "F" type headlamp system;

b. A vehicle is equipped with more than two driving lamps;

c. Driving lamps are not of an approved type or have been altered;

d. The color of the lamp is other than white;

e. The lens has a piece broken from it or is rotated away from its proper position. The lens may have one or more cracks provided an off-color light does not project through the crack or crack;

f. Wiring or electrical connections are defective;

g. Any driving lamp is mounted above the level of the regular headlamps, or is not mounted firmly to prevent excessive vibration;

h. Driving lamps are not wired so that they will burn only when the high beams of the regular headlamps are activated;

i. Driving lamps are not aimed so that the center of the hot spot drops three inches in 25 feet so that the hot spot is directly ahead of the lamp;

NOTE: Driving lamps must be aimed using the optical headlight aimer.

j. A tolerance of four inches in 25 feet is allowed in both the horizontal and the vertical adjustment;

11. Fog lamps are not required. However, if installed they must operate and be inspected.

Inspect for and reject if:

a. A vehicle is equipped with more than two fog lamps;

b. Lamps are not of an approved type or a lamp has been altered;

c. The lens is other than clear or amber. Fog lamps may have black-end bulbs or small metal caps over the end of the bulb;

d. The lens has a piece broken from it or is rotated away from its proper position. The lens may have one or more cracks provided an off-color light does not project through the crack or crack;

e. Wiring or electrical connections are defective;

f. Any fog lamp is mounted above the level of the regular headlamps, or is not mounted firmly;

g. Lamps are not wired and aimed according to the following instructions:

(1) Fog lamps are general illumination lamps as covered in subsection D of this section. They must burn through the tail light circuit even if on a separate switch. If installed on a vehicle with a four-headlamp system, or a vehicle equipped with driving lamps, they must be wired into the low beam circuit.

(2) Fog lamps must be aimed so that the top edge of the high intensity zone is set at the horizontal centerline and the left edge of the high intensity zone is set at the vertical centerline. (Same as low beam headlights.)

NOTE: Fog lamps must be aimed using the optical headlight aimer.

(3) A tolerance of four inches in 25 feet is allowed in both the horizontal and the vertical adjustment.

12. Spot lamps are not required. However, if installed they must operate and be inspected.

Inspect for and reject if:

a. Vehicle is equipped with more than two spot lamps;

b. Lamps are not of an approved type or a lamp has been altered;

c. The lens in any spot lamp is other than clear;

d. The lens has a piece broken from it or is rotated away from its proper position. The lens may have one or more cracks provided an off-color light does not project through the crack or crack;

e. Wiring or electrical connections are defective;

---

# Proposed Regulations

---

13. Daytime Running Lamps (DRLs) are not required. However, if installed they must operate and be inspected. DRLs must be installed in pairs.

NOTE: DRLs may or may not be wired into the tail light circuit.

Inspect for and reject if:

- a. Any lamp, except headlamps, used as DRLs is not marked "DRL;"
- b. Fog lamps or parking lamps are used as DRLs;
- c. More than one pair of lamps are used and or designated as DRLs;
- d. A DRL is mounted higher than 34 inches measured to the center of the lamp;
- e. The color is other than white to amber;
- f. DRLs do not deactivate when the headlamps are in any "on" position.

Any DRL optically combined with a turn signal or hazard lamp must deactivate when the turn signal or hazard lamp is activated and then reactivate when the turn signal or hazard lamp deactivates.

## 19 VAC 30-70-180. Clearance lamps and reflectors.

Inspect for and reject if:

1. Any motor vehicle, trailer, semitrailer or other vehicle is not equipped with clearance lamps if the vehicle is over 7 feet wide or if any portion extends 4 inches or more outside the front fender line.

NOTE: See 19 VAC 30-70-550 for vehicles exceeding 10,000 GVWR.

When a motor vehicle with a trailer attached is presented, the combination may be considered as one unit in meeting this requirement. If presented separately, the individual unit must meet these requirements.

2. Lamps and reflectors are not of an approved type or a lamp has been altered.

If the lamps or reflectors have unapproved plastic covers, any other materials which are not original equipment or any colored material placed on or in front of lamps or reflectors.

3. Lenses on lamps on the front are not yellow or amber and lenses on lamps on the rear are not red or if a lens has a piece broken from it. A lens may have one or more cracks provided an off-color light does not project through the crack or cracks.

4. Wiring or electrical connections are defective, all filaments do not burn.

5. Two amber lamps are not mounted on the front and two red lamps on the rear, so as to indicate the extreme width of the body, and as high on the permanent body as practical, except that approved 180 degree lamps

with yellow or amber lens may be mounted on the side of the vehicle at or as near the front as possible, or if the front is not the widest portion, the lamps may be installed on the side and as near that point as possible. And with the further exception that 180 degree lamps with red lens may be mounted on the side of the vehicle at or as near the rear as possible or if the rear is not the widest portion of the vehicle, the lamps may be installed on the side as near that point as possible.

6. Any vehicle equipped with three red identification lamps with the lamp centers spaced not less than six inches or more than 12 inches apart and installed as close as practicable to the top of the vehicle and as close as practicable to the vertical centerline of the vehicle may have the rear dimension or marker lamps required by subdivision 5, mounted at any height but indicate as nearly as practicable the extreme width of the vehicle.

7. Other specially constructed vehicles may be equipped with the required clearance lamps not mounted on the extreme rear, provided such red lamps are clearly visible from the rear and provided further that two red reflectors of an approved type are mounted on the extreme rear. In unusual cases the rear lamp may be mounted on the cab and another red reflex reflector placed on the extreme rear.

8. In addition to the required clearance lamps showing to the front and to the rear, a vehicle may be equipped with clearance lamps on the side of the vehicle. When such an installation is used, all of the clearance lamps on the side except the one at or near the rear must have an amber lens. The clearance lamps on the side at or near the rear must have a red lens.

9. Any vehicle covered by subdivision 1, except school buses, is not equipped with amber reflectors on the sides as near the front as practical, and red reflectors on the rear. The reflectors must be at least 24 15 inches and not more than 60 inches from the ground. No reflector can have a piece broken from its reflective surface, but may have one or more cracks.

10. Any combination of vehicles whose actual length exceeds 35 feet if the vehicles are not wide enough to have clearance lights, if the vehicle is not equipped with reflex reflectors of a type approved by the superintendent and mounted on the widest part of the towed vehicle so as to be visible from the front and sides of the vehicle. No reflector can have a piece broken from its reflective surface, but may have one or more cracks.

11. Any passenger vehicle is equipped with clearance lamps, unless such lamps are used to mark the extreme width of the vehicle or used as taxicab identification, or used as supplemental turn signals. (See 19 VAC 30-70-190, ~~subsection B.~~)

12. Vehicles so constructed as to make compliance with the requirements of 19 VAC 30-70-180,

subdivisions 1, 5, 7, 9 and 10 impractical will be equipped with clearance lamps and reflectors at the

most practical location to provide maximum visibility.

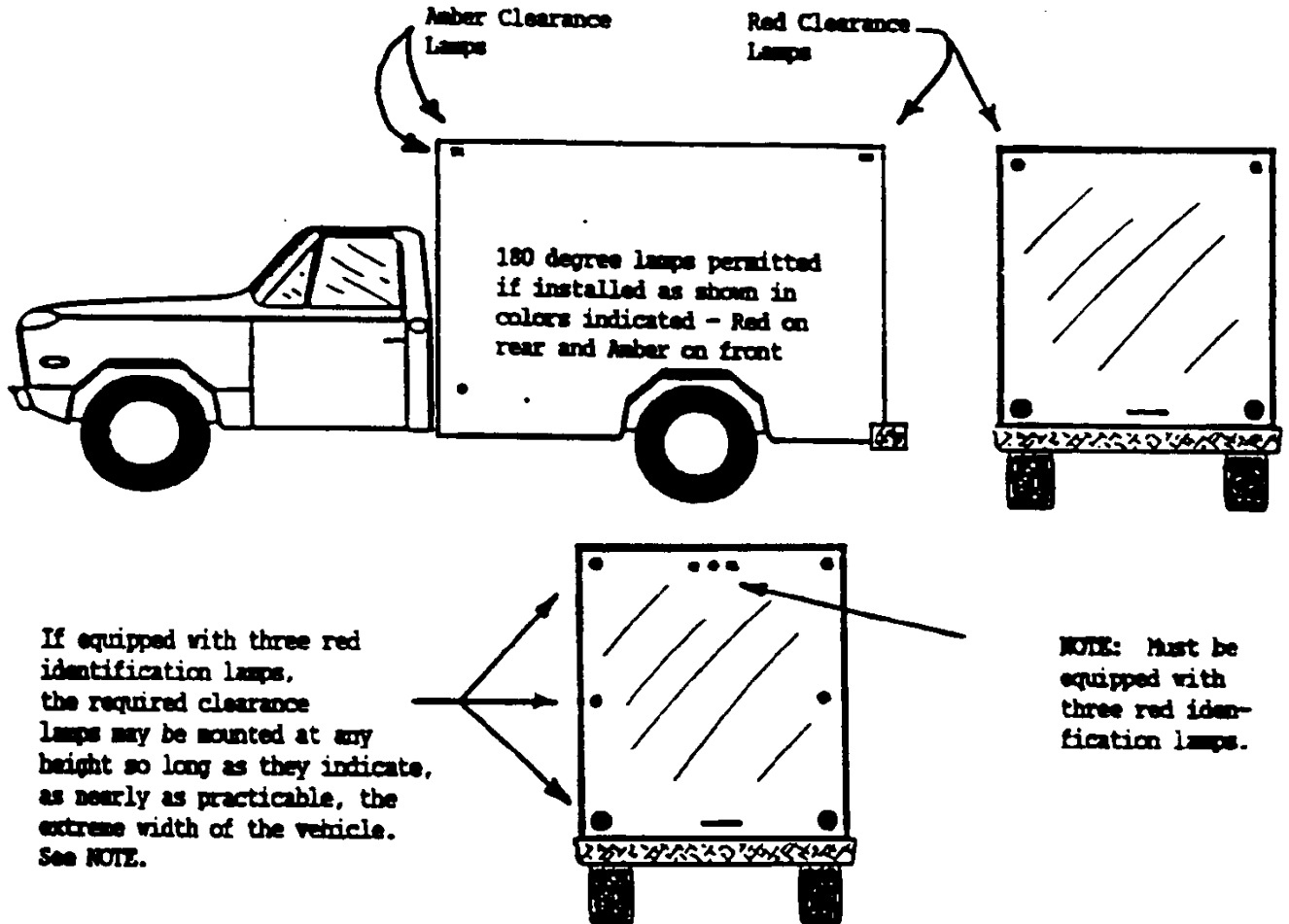

ILLUSTRATIONS FOR PROPER INSTALLATION OF REFLECTORS

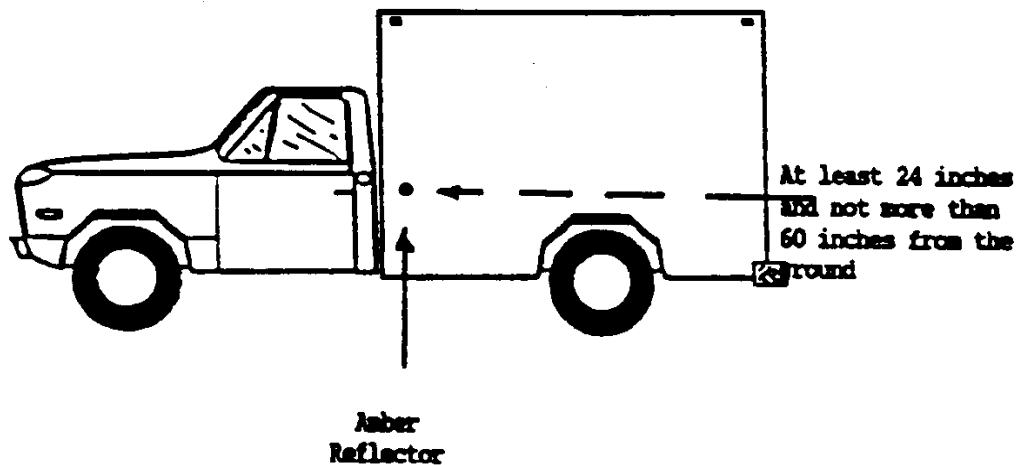

---

# Proposed Regulations

---

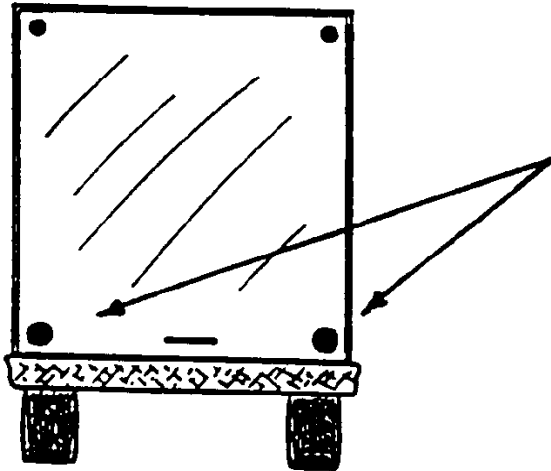

Red Reflectors ——— At least 24 inches and not more than 60 inches from the ground

## 19 VAC 30-70-200. Permissible lighting equipment.

A. Any vehicle may be equipped with:

- ~~1. Magneto or acetylene lighting, if original equipment and if otherwise in conformity with these rules and regulations and Virginia statutes;~~
- ~~2.~~ 1. Running board or courtesy lamps, of not over six candlepower;
- ~~3.~~ 2. Vacant or destination signs, if a taxicab or bus;
- ~~4.~~ 3. Identification lamps of approved type;
- ~~5.~~ Front fender clearance jewels, if amber or yellow;
- ~~6.~~ 4. Interior lights, not more than 15 candlepower;

Exception: This does not apply to alternating, blinking or flashing colored emergency lights mounted inside law enforcement vehicles or flashing shielded red or red and white lights, mounted inside vehicles owned by members of volunteer fire companies, volunteer rescue squads or owned or used by professional firefighters.

- ~~7.~~ 5. Hood ornament light if of a type approved or permitted by the superintendent;
- ~~8.~~ 6. Any approved lamp in good working order when used for the purpose for which it was approved;

B. Side Marker Lamps-Side marker lamps are not required. If installed they must operate and be inspected. If the bulb, socket and wiring are removed from an individual lamp unit, the unit will not be considered during inspection.

C. Inspect for and reject if:

1. Lamps are not of an approved type, or do not comply with subdivision 1 of this section;
2. Lamps are not installed on the permanent structure of the vehicle with one as far to the rear and one as far forward as practicable and at a location which is not less than 15 inches above the road surface when measured from the center of the lamp;

3. Lamps installed on the side to the rear do not project a red light and lamps installed on the front do not project an amber light;
4. Lens has a piece broken from it. The lens may have one or more cracks provided no off-color light projects through the crack or cracks;
5. Any vehicle has unapproved lens or plastic covers, any other materials which are not original equipment or any colored material placed on or in front of permissible lighting equipment;
6. Wiring or electrical connections are defective or filaments do not burn.

## 19 VAC 30-70-440. Service brakes.

A. The inspector, as a minimum must drive all vehicles into the inspection lane and test both service and parking brakes, except vehicles the inspector is not qualified to drive. In these cases, the inspector will ride in the vehicle and observe the application of the brakes.

B. A minimum of one wheel or one wheel and drum or dust cover must be removed from each vehicle at the time of inspection except:

1. Vehicles having open brake mechanisms which will permit the inspection of the brake lining, or discs and disc pads, without removing the wheel and rim.

WARNING: Failure to properly torque lug nuts may cause severe damage to the wheel.

2. The inspection receipt (approval and rejection) shall be marked to reflect which wheel and drum or dust cover was removed or inspected.

C. If any braking problem is detected, the inspector may test drive or require a test drive of the vehicle and use the decelerometer as necessary. If the decelerometer is used and the vehicle does not meet the minimum standards for stopping distances, as shown in paragraph F, the vehicle should be rejected.



D. Inspect for and reject if:

1. Vehicles equipped with air brakes: when the air brake adjustment on vehicles is equal to or exceeds Table #1 for cam brakes or brake shoe travel is greater than 1/16" on wedge brakes when measured according to Illustrations #1 and #2. (See Procedure in addition to illustrations.)

**TABLE 1  
MINIMUM CRITERIA FOR BRAKE ADJUSTMENT**

Brake adjustment shall not exceed those specifications contained in the following tables relating to maximum stroke at which brakes should be re-adjusted.

(Dimensions in Inches)

Effective Area (Sq. In.)	Outside Diameter	Maximum Stroke	Maximum Stroke With Brakes Adjusted	Maximum Stroke at Which Brakes Should be Readjusted
<b>BOLT TYPE BRAKE CHAMBER DATA</b>				
12	6 15/16	1 3/4	Should be as short as possible without brakes dragging	1 3/8
24	9 3/16	2 1/4		1 3/4
16	8 1/16	2 1/4		1 3/4
6	5 1/4	1 5/8		1 1/4
9	6 3/15	1 3/4		1 3/8
36	11	3		2 1/4
30	9 7/8	2 1/4		2
<b>ROTOCHAMBER DATA</b>				
9	4 9/32	2	Should be as short as possible without brakes dragging	1 1/2
12	4 13/16	2		1 1/2
16	5 13/32	2 1/2		1 7/8
20	5 15/16	2 1/2		1 7/8
24	6 13/32	2 1/2		1 7/8
30	7 1/16	3		2 1/4
36	7 5/8	3 1/2		2 5/8
50	8 7/8	4		3
<b>CLAMP TYPE BRAKE CHAMBER DATA</b>				
6	4 1/2	1 5/8	Should be as short as possible without brakes dragging	1 1/4
9	5 1/4	1 3/4		1 3/8
12	5 11/16	1 3/4		1 3/8
16	6 3/8	2 1/4		1 3/4
20	6 25/32	2 1/4		1 3/4
24	7 7/32	2 1/4		1 3/4
30	8 3/32	2 1/2		2
36	9	3		2 1/4

WEDGE BRAKE DATA				
Movement of the scribe mark on the lining shall not exceed 1/16 inch; and failure of the brake shoes to move shall constitute a violation.				
AIR DISC BRAKES - PUSH ROD LIMITS BRAKE ADJUSTMENT RECOMMENDATIONS				
Chamber Size	Stroke (In Inches) at Initial Adjustment			Maximum Stroke (In Inches) Before Readjustment
12	1 3/8			1 5/8
16	1 1/2			1 7/8
20	1 5/8			2
24	1 3/4			2 1/8
30	1 7/8			2 1/4
BENDIX WESTINGHOUSE				
DD2				2
DD3				2

Dimensions listed do not include capscrew head projections for rotochambers and bolt clamp projections for clamp-type brake chambers.

**PROCEDURE FOR MEASURING CAM AND WEDGE BRAKES**

- On vehicles equipped with Cam brakes, mark each brake chamber push rod at the face of the brake chamber with the brakes released. Apply the air brakes fully, minimum air pressure of 90 to 100 psi, and measure the distance the push rod travels from the face of the chamber to the mark previously made when the brakes were released. This measurement is the push-rod stroke (see Table).

- On vehicles equipped with wedge brakes, remove the inspection hole cover at each dust shield and with the brakes released, scribe a line on the edge of the brake lining. Apply the air brakes fully and measure the distance the brake lining travels.

# Proposed Regulations

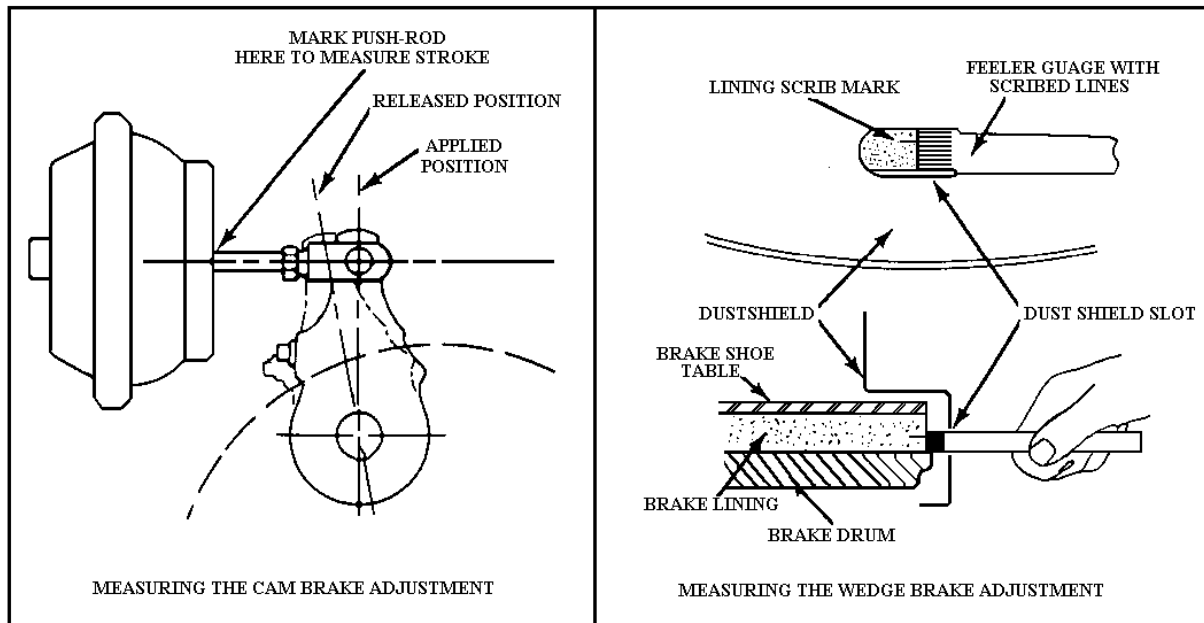

2. *Brake hose and tubing.* There is any leakage in any hydraulic, air or vacuum lines; hoses have any cracks, crimps, restrictions, or are abraded exposing fabric into second ply of fabric; tubing or connections leak, are crimped, restricted, cracked, or broken; ~~any valves leak or are inoperative.~~

- a. *Hose with any damage extending through the reinforcement ply. Rubber impregnated fabric cover is not a reinforcement ply. Thermoplastic nylon may have braid reinforcement or color difference between cover and inner tube. Exposure of second color is cause for rejection.*
- b. *Bulge or swelling when air pressure is applied.*
- c. *Two hoses improperly joined (such as a splice made by sliding the hose ends over a piece of tubing and clamping the hose to the tube).*

3. *Service brakes.* There is less than 1/5 reserve in pedal travel of the service brake when fully applied on all hydraulic, mechanical, or power-assisted hydraulic braking systems.

4. When tested on dry, hard, approximately level road free from loose material, at a speed of 20 miles per hour without leaving a 12-foot wide lane, a ~~brake machine or decelerometer reading distance~~ in excess of the following stopping distance is obtained: ~~(When in doubt about a vehicle's stopping ability, the inspector shall conduct or observe a road test.)~~

Any bus, truck or tractor—40 feet;

All combinations of vehicles—40 feet.

5. Every motor vehicle, trailer or semitrailer which is not equipped with operational brakes on all wheels (except

as shown in a, below), or any brake has been disconnected or rendered inoperative or improperly installed.

- a. Road tractors, tractor trucks, or trucks if manufactured prior to July 25, 1980, having three or more axles are not required to have brakes on the steering axle; however, if installed must be inspected and meet all requirements of this section.
- b. *Missing, bent or broken mechanical components including: shoes, lining pads, spring, anchor pin, spiders, cam rollers, push rods and air chamber mounting bolts, air reservoirs not securely mounted or leaks.*
- c. *Absence of braking action on any axle required to have brakes, upon application of the service brakes (such as missing brakes or brake shoes, failing to move upon application of a wedge, S-cam or disc brake).*
- d. *Loose brake components including air chambers, spiders and cam shaft support brackets.*
- e. *Audible air leak at brake chamber (example: ruptured diaphragm, loose chamber clamp, etc.)*

## Brake Linings and Disc Pads:

6. ~~Rivets or bolts are loose or missing.~~
7. ~~Lining or pad broken or cracked so that pad or lining or parts of pad or lining are not firmly attached to the shoe or has cracks on the friction surface extending to the open edge.~~
6. *Linings or pads are broken or cracked so that brake pad is not firmly attached to the shoe or improperly*

installed or, cracks on the friction surface extends to the open edge.

a. Rivets or bolts are loose or missing

~~8-~~ b. Lining or pad friction surface is saturated with oil, grease or brake fluid.

~~9-~~ Thickness of bonded lining or pad is less than 3/16 of an inch at the thinnest point.

~~10-~~ Brake linings and pads (riveted only).

a. Air brakes - All axles except steering.

(1) ~~9/32 of an inch or less, measured at center of shoe or to wear indicators, if so equipped.~~

(2) ~~Steering axle - 6/32 of an inch or less, measured at center of shoe, or to wear indicators, if so equipped.~~

b. Hydraulic and electric.

(1) ~~All axles except steering - 6/32 of an inch or less, measured at center of shoe, or to wear indicators, if so equipped.~~

(2) ~~Steering axle - 4/32 of an inch or less, measured at center of shoe, or to wear indicators, if so equipped.~~

~~11-~~ Thickness of bolted lining is less than 5/16 of an inch measured at the shoe center.

~~E. On School Buses Only. INSPECT FOR AND REJECT IF:~~

~~1-~~ Thickness of bonded lining or pad is less than 2/32 of an inch at the thinnest point.

~~7-~~ Nonsteering axles. Lining with a thickness less than 1/4 inch at the shoe center for air drum brakes. 1/16 inch or less at the shoe center for hydraulic and electric drum brakes and less than 1/8 inch for air disc brakes, lining with a thickness less than 3/16 inch for a shoe with a continuous strip of lining or to wear indicators if so equipped.

a. Steering axles. Lining with thickness less than 1/4 inch at the shoe center from drum brakes, less than 1/8 inch for air disc brakes and 1/16 inch or less for hydraulic disc and electric brakes, lining with a thickness less than 3/16 inch for a shoe with a continuous strip of lining or to wear indicators if so equipped.

b. Mismatch across any power unit steering axle of:

(1) Air chamber sizes.

(2) Slack adjuster length.

~~2-~~ 8. Thickness of riveted or bolted lining is less than 2/32 of an inch above the rivet or bolt head(s).

~~3-~~ 9. Any lining or pad is misaligned or does not make full contact with the drum or rotor.

## Brake Drums and Discs:

~~4-~~ 10. Brake drums or brake discs (rotors) are worn or scored to the extent that their remachining would ~~exceed~~ result in a failure to meet manufacturer's specifications.

~~5-~~ 11. Brake drums or discs with any external crack or cracks ~~more than 1/2 the width of the friction surface of the drum or disc that open upon brake application.~~

NOTE: Do not confuse short hairline heat cracks with flexural cracks.

## Mechanical Linkage:

~~6-~~ Cables are frayed or frozen.

~~7-~~ Mechanical parts missing, broken, badly worn, or misaligned.

~~12-~~ Any portion of the drum or rotor missing or in danger of falling away.

## Hydraulic:

NOTE: Some motor vehicles, beginning with 1976 models, have a hydraulic power system that serves both the power assisted brakes and power assisted steering system. Some vehicles, beginning with 1985 models, have an integrated hydraulic actuation and anti-lock brake unit using only brake fluid.

## Hydraulic System Operation:

~~8-~~ 13. Stop engine, then depress brake pedal several times to eliminate all pressure. Depress pedal with a light foot-force (30 pounds). While maintaining this force on the pedal, start engine and observe if pedal moves slightly when engine starts.

Reject vehicle if pedal does not move slightly as engine is started while force is on brake pedal.

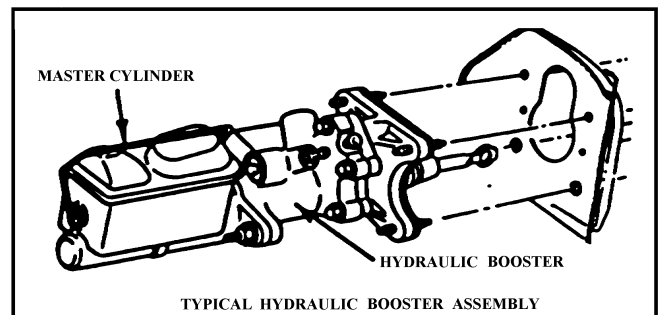

## Condition of Hydraulic Booster Power Brake System:

~~9-~~ 14. Inspect system for fluid level and leaks. Reject vehicle if there is insufficient fluid in the power steering pump reservoir; if there are broken, kinked or restricted fluid lines or hoses; if there is any leakage of fluid at the pump, steering gear or brake booster, or any of the lines or hoses in the system; or if belts are frayed, cracked or excessively worn.

## Integrated Hydraulic Booster/Anti-Lock System Operation:

# Proposed Regulations

40- 15. With the ignition key in the off position, depress brake pedal a minimum of 25 times to deplete all residual stored pressure in the accumulator. Depress pedal with a light foot- force (25 lbs.). Place ignition key in the on position and allow 60 seconds for the brake warning light to go out and the electric pump to shut off.

Reject vehicle if the brake pedal does not move down slightly as the pump builds pressure or if the brake and anti-lock warning lights remain on longer than 60 seconds.

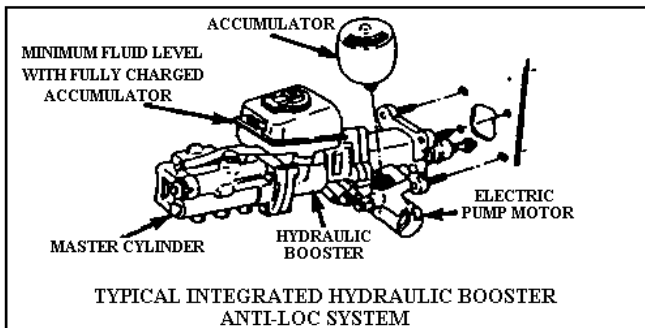

Condition of Integrated Hydraulic Booster/Anti-Lock System with Electronic Pump:

44- 16. With the system fully charged, inspect system for fluid level and leaks.

Reject vehicle if there is insufficient fluid in the reservoir; if there are broken, kinked or restricted fluid lines or hoses; or if there is any leakage of fluid at the pump or brake booster, or any of the lines or hoses in the system.

Vacuum System Operation:

42- 17. Stop engine then depress brake pedal several times to eliminate all vacuum in the system. Depress pedal with a light foot-force (25 lbs.). While maintaining this force on the pedal, start engine and observe if pedal moves down slightly when engine starts.

Reject vehicle if pedal does not move down slightly as engine is started while force is on the brake pedal. In full vacuum-equipped vehicles, there is insufficient vacuum reserve for one full service brake application after engine is stopped.

- a. Has insufficient vacuum reserve to permit one full brake application after engine is shut off.
- b. Lacks an operative low-vacuum warning device as required.

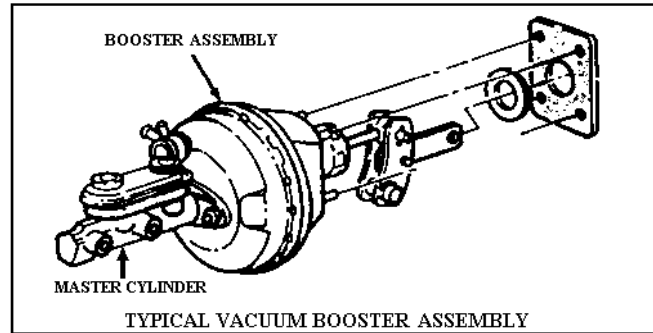

Condition of Vacuum Booster Power Brake System:

43- 18. Visual inspection. Reject vehicle if there are collapsed, cracked, broken, badly chafed or improperly supported hoses and tubes, loose or broken hose clamps.

44- 19. There is any leakage in the hydraulic system. (Do not disturb the dust boot when checking for leaking wheel cylinders.)

45- 20. Fluid level in master cylinder is below the proper level for the particular vehicle.

46- 21. There is any evidence of a caliper sticking or binding.

~~Vacuum System and Air Brake System Brakes:~~

~~17. Brakes on tractor or truck will not release.~~

~~18. Air cleaners clogged sufficiently to prevent proper intake of air.~~

~~19. Piston packings, valves, diaphragms, piston cups or fittings leaking.~~

~~20. Trailer brake chamber rods do not follow application of tractor brake pedal, or do not reach full released position.~~

~~21. Time required to build up air pressure from 50 to 90 pounds per square inch (PSI) is more than 5 minutes with engine running at fast idle.~~

~~22. Motor vehicle is equipped with air brakes and does not have an operating air pressure gauge.~~

~~23. The low air warning device connected on the low pressure indicator of the air brake system does not operate when air pressure is lowered to a range of 50 to 70 PSI. The vehicle is not equipped with a low air warning device or if device has been rendered inoperative.~~

23. Any bus, truck, road tractor and tractor truck manufactured after ~~February 28, 1975~~ *March 15, 1975*, must have a visible low air warning device. Those manufactured on or before ~~February 28, 1975~~ *March 15, 1975*, may have either an audible or visible low air warning device.

*a. Low pressure warning device missing, inoperative or does not operate at 55 psi and below or ½ the governor cut out pressure whichever is less.*

~~24. Governor cut-in pressure is lower than 80 PSI or cut-out pressure higher than 125 PSI, unless other values are specified by the manufacturer.~~

~~25. 24. Compressed air reserve is not sufficient to make one full service brake application after engine is stopped, or with system fully charged, the reservoir pressure is lowered more than 20 30% by one full brake application.~~

*a. Brake chamber push rods do not follow application of service brake pedal, or do not reach full released position (example: defective return spring).*

~~26. Air brake leakage rate with engine stopped and service brakes released in one to five minutes exceeds:~~

~~2 PSI/per minute for single vehicles~~

~~3 PSI/per minute for combination of vehicles (additional 2 PSI/per minute drop allowed for each additional towed vehicle).~~

~~NOTE: It will be necessary to record the pressure over a time interval corresponding to the test gauge increments for accuracy.~~

~~27. Air brake leakage rate with engine stopped and service brakes fully applied in one minute exceeds:~~

~~3 PSI for single vehicles~~

~~4 PSI for combination of vehicles (additional 2 PSI is allowed for each additional towed vehicle).~~

~~28. Air reservoirs not securely mounted or leaks.~~

~~29. Brake chambers, relay devices, and other valves are not securely attached.~~

~~30. Slack adjusters and actuators (push rods) are bent, broken, or have missing parts.~~

~~31. Air safety relief valve is defective or inoperative.~~

~~32. Compressor belt does not have sufficient tension or is worn or frayed. Compressor mounting has loose, broken or missing bolts or other attaching parts.~~

~~33. Air hoses, glad hands or gaskets are missing, broken or worn so as to allow any air leakage. Flexible air hoses are worn or damaged through the outer casing and into the second ply. Any bulging in air hose is observed when air pressure is in line. Any hose is cracked, broken or crimped. Hoses are not secured against chafing, binding or other mechanical damage. Hoses are not installed in a manner that prevents them from coming in contact with vehicle's exhaust system.~~

~~34. 25. Any bus, truck, road tractor, or tractor truck manufactured after February 28, 1975, if equipped with a manually operated device to reduce or remove the braking effort upon its front wheels.~~

~~Electric Brake System Brakes:~~

~~35. 26. Trailers show an amperage value more than 20% above or 30% below the brake manufacturer's maximum current rating for each brake.~~

~~36. 27. Ammeter shows no reading or indicator is not steady on application and release of brake controller.~~

~~37. 28. Any terminal connections are loose or dirty; wires are broken, frayed or unsupported; any single conductor or nonstranded wire or wires below size recommended by brake manufacturers are installed.~~

~~38. 29. Electrical trailer brakes do not apply automatically when breakaway safety switch is operated.~~

~~30. Absence of braking action on any wheel required to have brakes.~~

~~31. Missing or inoperative breakaway braking device(s).~~

~~Air Compressor:~~

~~32. Compressor drive belts in condition of impending or probable failure.~~

~~33. Loose compressor mounting bolts or compressor leaks.~~

~~34. Cracked, broken or loose pulley.~~

~~35. Tractor protection valve(s) is defective or inoperative.~~

~~36. Air safety relief valve is defective or inoperative.~~

## **19 VAC 30-70-450. Brakes.**

A. Some vehicles are equipped with an actual emergency brake, while others have only a parking or holding brake. Some types may be actuated by a foot or hand lever, while others may incorporate a switch or valve to actuate the brake. Air and vacuum brake systems may employ spring activating parking brakes.

B. Inspect for and reject if:

1. Vehicle or combination of vehicles is not equipped with a parking, holding, or emergency brake in good working order of the type installed as original standard factory equipment for the vehicle on which it is installed.

2. The parking brake actuating mechanism does not fully release when the control is operated to the off position.

3. Any mechanical parts are missing, broken, badly worn, or are inoperative.

4. Cables are stretched, worn, or frayed or not operating freely.

5. Parking brake will not hold the vehicle stationary with the engine running at slightly accelerated speed with shift lever in drive position for automatic transmission or shift lever in low gear with clutch engaged for standard shift transmission.

---

# Proposed Regulations

---

6. On vehicles equipped with automatic transmissions, the vehicle will start in any gear other than (P) park or (N) neutral.

7. *Any nonmanufactured hole(s) in the spring brake housing section of a parking brake.*

8. *All commercial motor vehicles manufactured after March 7, 1990, shall be equipped with a parking brake system adequate to hold the vehicle or combination under any condition of loading except agricultural commodity trailers, converter dollies, heavy haulers and pulpwood trailers.*

## **19 VAC 30-70-460. Brakes: trailer (GVWR 10,000 pounds or more).**

A. All trailers and semitrailers registered for or having an actual gross weight of 10,000 pounds or more shall be equipped with operational brakes acting on all wheels.

B. Inspect for and reject if:

1. Trailer brakes do not comply with provisions of 19 VAC 30-70-430 and 19 VAC 30-70-440 *and 19 VAC 30-70-450.*

2. Operator does not have full control over brakes.

3. Combination will not stop as required in ~~19 VAC 30-70-430~~ 19 VAC 30-70-440 D 4.

4. ~~All Trailers, manufactured or assembled after January 1, 1964~~ are not equipped with emergency breakaway brakes designed to:

- a. Apply automatically upon breakaway from towing vehicle.
- b. Remain fully applied for at least 15 minutes.
- c. Apply and release by operation of the manual emergency control.
- d. Apply automatically when the pressure in the towing vehicle reservoir is reduced to a point between 45 and 20 PSI by a series of foot applications, when equipped with air brakes.

5. A minimum of one wheel must be removed from each axle equipped with brakes to inspect the brake components.

Exceptions:

- a. Wheels on trailers equipped with open brake mechanisms are not required to be removed.
- b. The inspection receipt shall be marked to reflect on which side the wheel or wheels were pulled or inspected.

## **19 VAC 30-70-470. Steering.**

A. This system requires moving components to be checked for steering wheel lash, loose parts or binding. To properly inspect the power steering components, the engine must be running.

B. Inspect for and reject if:

1. Play at any point in the steering mechanism is excessive. The steering mechanism is unusually tight and binding when turning the steering wheel completely to the right and left. The steering mechanism will not turn in both directions, stop to stop, or steering stops have been removed. On certain model passenger buses, it may be necessary to open the inspection access door to allow visual inspection of the steering shaft universal joints.

2. Power steering is defective and affects adequate steering of the vehicle or fluid level in reservoir is below operating level. Belts do not have sufficient tension or are worn, frayed, or missing. Damage to hoses or leaks in hoses or fittings.

3. Any modification has been made to any part of the steering system that affects proper steering. A repair kit or preventive maintenance kit has been installed on a tie rod end, idler arm, ball joint, or any other part of the vehicle's steering gear.

NOTE: The repair kit or preventive maintenance kit usually consists of a small spring and a plastic cap which is placed over the bolt stud of the component and held in place by a retaining nut. There is nothing in this paragraph which prohibits the replacement of parts or components of a motor vehicle's steering gear in order to correct deficiencies in the steering gear.

4. Steering Lash/Travel-Trucks.

a. Before inspection the vehicle must be placed on a smooth, dry, level surface. For vehicles equipped with power steering, the engine must be running and the fluid level, belt tension and condition must be adequate before testing.

b. With road wheels in straight ahead position, turn steering wheel until motion can be detected at the front road wheels. Align a reference mark on steering wheel with a mark on a ruler and slowly turn steering wheel in the opposite direction until motion can be detected at the front road wheel. Measure lash at steering wheel. Special lash-checking instruments are also available, measuring free play in inches or degrees. Such instruments should always be mounted and used according to the manufacturer's instructions. With vehicle raised, visually inspect steering linkage, ball studs, tie rod end socket assemblies and all pivot points.

NOTE: On vehicles with power steering, engine must be running.

c. Reject vehicle if steering wheel movement exceeds:

Steering Wheel Size and Lash

Power Steering		Manual Steering	
16 in. or less	- 4½ in.(11.5cm)	16 in. or less	- 2 in. (5.1cm)
18 in.	- 4¾ in.(12.0cm)	18 in.	- 2¼ in.(5.4cm)
20 in.	- 5¼ in.(13.5cm)	20 in.	- 2½ in.(6.4cm)
22 in.	- 5¾ in.(14.5cm)	22 in.	- 2¾ in.(7.0cm)

d. Reject vehicle if visual inspection reveals excessive wear and/or looseness in any ball stud, end assembly, pivot point or mechanical linkage.

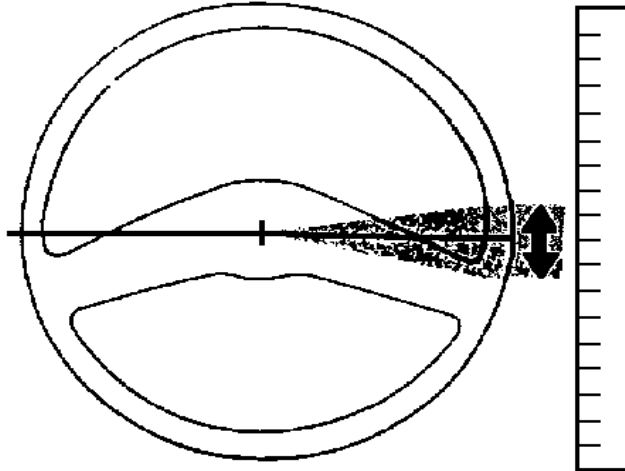

STEERING LASH

5. Any modification or replacement has been made to the steering wheel which affects proper steering. It shall be rejected if it is of a smaller size than the original factory equipment.

6. Steering column has any missing or loose bolts or positioning parts, resulting in motion of the steering column from its normal position. Steering shaft universal joints are loose or exhibit any abnormal movement when shaft is rotated. *Any welded repairs are made to the steering system, steering column, steering gear box, pitman arm or universal joints.*

a. *Any movement of a steering nut under steering load.*

7. Any missing or loose bolts or other parts resulting in motion of the steering gear box at the point of attachment to the vehicle's frame.

8. Any looseness or up and down movement of the pitman arm or on the steering gear box, output shaft or gear box.

9. Any control arm bushing is missing.

10. *Any vehicle equipped with an idler arm shows excessive looseness.*

11. *Any motion, other than rotational, between any linkage member and its attachment point of more than ¼ inch measured with hand pressure only.*

12. *Loose clamps, clamp bolts on tie rod ends or drag links.*

13. *Any looseness in any threaded joint.*

14. *Loose or missing nut on tie rods, pitman arm, drag ink, steering arm or tie rod ends.*

15. Wheel Bearings/Steering Linkage.

a. With the front end of vehicle lifted properly, push pads away from rotor on disc brakes, and grab front tire at top and bottom, rock vigorously in and out and record movement. Wheel bearing looseness is detected by the relative movement between the brake drum or disc and the backing plate or splash shield.

(1) Reject vehicle if relative movement between drum and backing plate (disc and splash shield) is more than ¼ inch measured at the outer circumference of the tire for vehicles more than 10,000 pounds GVWR.

(2) Reject vehicle if any wheel bearing is excessively worn or not properly adjusted; any cotter key or other locking device is missing or inoperative.

b. Steering Linkage Play. First eliminate all wheel bearing movement by applying service brake. With vehicle lifted as shown below and wheels in straight ahead position, grasp front and rear of tire and attempt to move assembly right and left without moving the steering gear.

Reject vehicle if measured movement at front or rear of tire is greater than:

Wheel size: 16 inches or less - ¼ inch

17 to 18 inches - ⅜ inch

over 18 inches - ½ inch

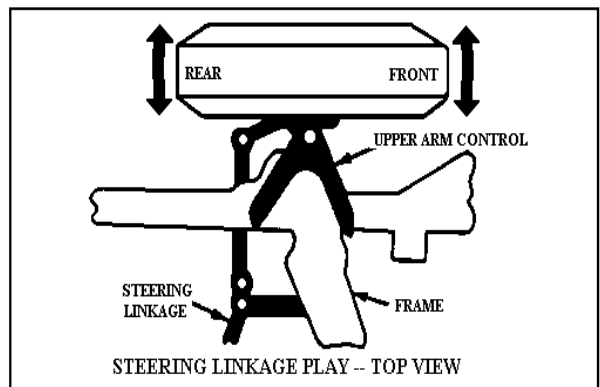

c. Kingpin Play. If vehicle is equipped with kingpins, first eliminate all wheel bearing movement by applying service brake. With front end lifted as illustrated for inspecting wheel bearings, (Figure C) grasp the tire at the top and bottom and attempt to move in and out to detect looseness. Measure the movement at the top or bottom of the tire at the outer circumference.

# Proposed Regulations

Reject vehicle if measured movement at top or bottom of tire is greater than:

Wheel size: 16 inches or less - ¼ inch

17 to 18 inches - ⅜ inch

over 18 inches - ½ inch

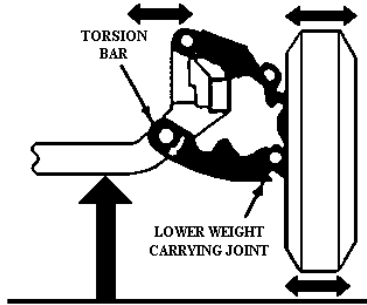

FIGURE A

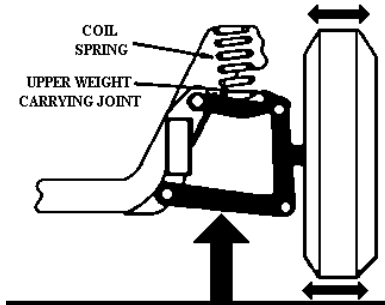
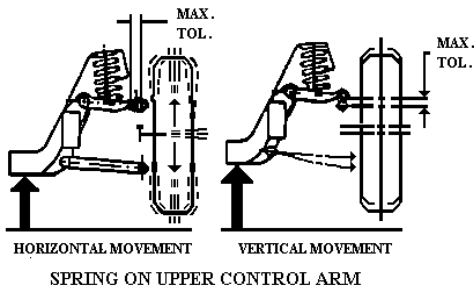
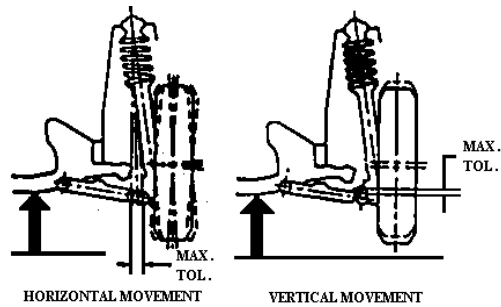

FIGURE B



SPRING ON UPPER CONTROL ARM

FIGURE 1



MACPHERSON STRUT

FIGURE 2

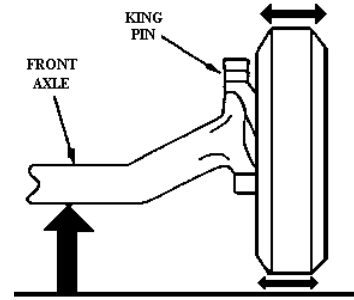

FIGURE C

41. ~~Any vehicle equipped with an idler arm showing excessive looseness.~~

42. 16. Ball Joint Wear: There is a trend among U.S. automobile manufacturers toward the use of "wear-indicating" ball joints on light trucks. Many vehicles on the road, however, do not have wear-indicating ball joints. The inspection of both types will be discussed.

Figures 1, 2, 3 and 4 below illustrate the proper hoisting for checking ball joints.



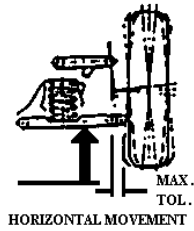

FIGURE 3

SPRING OR TORSION BAR ON LOWER CONTROL ARM  
RAISING POSITIONS FOR SUSPENSION SYSTEMS

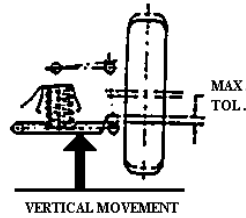

FIGURE 4

a. NOTE: To check ball joint wear on vehicles when the spring is supported on the upper control arm or when the spring is a part of a MacPherson strut or wear in any other type suspension not using ball joints when the front wheels are suspended on a solid axle, the vehicle must be hoisted as shown in Figure 1 or 2.

b. NOTE: Upper control arm must be stabilized in normal load carrying position by means of an upper control or other support tool to insure ball joint is in unloaded position.

c. NOTE: To check ball joint wear on vehicles not listed in above referred to section and diagram or tables when the spring is supported on the lower control arm; and to check the kingpin wear in any other type suspension not previously described when the wheels are independently suspended, the vehicle must be hoisted as shown in Figure 3 or 4.

13- 17. Vehicles Without Wear Indicator Ball Joint.

a. Reject vehicle if there is noticeable play in the lower ball joint when hoisted as in Figures 1 or 2, or in the upper ball joint when hoisted as in Figures 3 or 4.

b. Reject vehicle if there is lateral movement in either front wheel in excess of 1/4 inch measured at the outside of the tire up to and including a 16-inch wheel; or in excess of 3/8 inch when the wheel is over 16 inches. This check must be made by grasping the tire at the extreme top and bottom and moving the wheel laterally across the surface. If play is noted, accurate measurement must be made by using the block test or with an accurate measuring device. No rejection should be made unless the specified tolerances are exceeded.

44. 18. Ball Joints With Wear Indicators (Trucks): Support vehicle with ball joints loaded (in normal driving attitude). Wipe grease fitting and checking surface free of dirt and grease. Determine if checking surface extends beyond the surface of the ball joint cover.

a. Reject vehicle if checking surface is flush with or inside the cover surface.

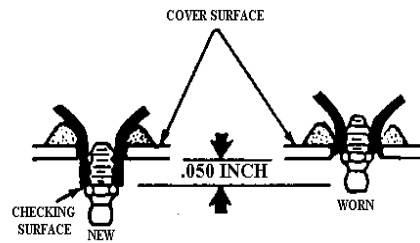
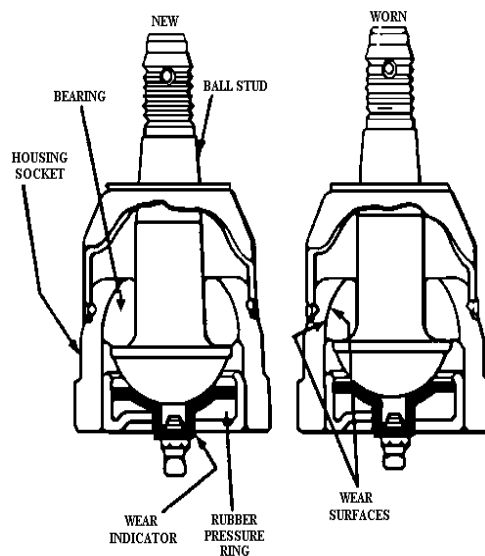

BALL JOINT WEAR INDICATOR

Wear is indicated by the protrusion of the 1/2" diameter boss, (exaggerated for illustration) into which the grease fitting is threaded for greasable ball joints. This same boss exists and should be used to indicate wear in non-greasable ball joints. This round boss projects .050" beyond the surface of the ball joint cover on a new, unworn joint.

To inspect for wear, support vehicle by wheels so that the lower ball joints are in a loaded condition. Wipe the grease fitting or boss free of dirt and grease. Observe or scrape a scale, screwdriver or fingernail across the cover. If the grease fitting boss is flush or inside the cover surface, reject vehicle.

# Proposed Regulations

45-19. Any vehicle inspected in accordance with the recommendation of the manufacturer of such vehicle and found to be within the specification contained in the attached chart in subdivision 12 shall be deemed to meet inspection regulations.

TABLE 1 MANUFACTURER'S TOLERANCE FOR BALL JOINT WEAR WITH SPRING OR TORSION BAR ON LOWER ARM

Model	Year	Vertical Movement	Horizontal Movement
<b>CHEVROLET</b>			
10, 20, 30	60-84	.094"	.250"
S-Series	82-84	Wear Ind.	(a)
<b>GMC</b>			
1500, 2500, 3500	60-84	.094"	.250"
S-Series	82-84	Wear Ind.	(a) .250"
<b>DODGE</b>			
B1, B2, B3, D1, D2, D3, D15, D25, D35, W2, W3, W15, W25, W35, RD2, WM3, MB3, CB3, AD1, AW1, Ramcharger	71-84	.020"(b)	(a)
Rampage	82-84	.000	.000
<b>PLYMOUTH</b>			
PB1, PB2, PB3, PD1, PW1, Trail Duster	74-84	.020"(b)	(a)
<b>INTERNATIONAL</b>			
100, 150, 200	74-80	.095"	(a)

(a) Do not test ball joints by Horizontal Movement.

(b) Preloaded by rubber or springs.

## 19 VAC 30-70-480. Suspension.

Inspect for and reject if:

1. Any positioning parts are cracked, broken, loose, or missing resulting in shifting of an axle from its normal position.
2. Any part of the torsion bar assembly or torque arm or any part used for attaching the same to the vehicle frame or axle which is cracked, broken or missing.

*NOTE: This does not apply to loose bushing(s) in torque or track arms.*

3. Vehicles designed for shock absorbers or cross stabilizer links, if any are missing, disconnected, broken, bent, loose or do not function properly.
4. Any leaf spring is broken, sagging, misaligned, or if ~~shackles~~ spring hangar(s) are worn or loose.

5. Any ~~deflated~~ air suspension ~~leaking that affects the normal function of the suspension system or is seriously~~

~~deteriorated (cracks, patches, rubber soft or oil soaked) system or leaks.~~

CAUTION: Underneath inspection of a vehicle equipped with air suspension with excessive leakdown could result in serious personal injury.

6. Any suspension system defect or any condition of loading that permits the body or frame to come in contact with a tire or any part of the wheel assemblies.

NOTE: "All thread rod" material shall not be used as U-bolts in the suspension system.

7. Sliding trailer tandem or multi-axle assemblies do not lock in place or have broken or missing parts.

8. Any coil spring is broken.

9. Vehicles with composite trailer springs if a crack, regardless of length, is visible on either side, top or bottom.

NOTE: A crack is a separation in any axis which passes completely through the spring.

## 19 VAC 30-70-490. Frame, engine mounts, coupling devices and emergency chains.

Inspect for and reject if:

~~1. Frame or unitized body of any motor vehicle, trailer or semitrailer is broken or cracked at any location, including any welded joint and/or is rusted or corroded to the point the frame is weakened of any bus, truck, truck tractor is cracked, loose or sagging.~~

a. Frame of any trailer or semi-trailer has any broken or cracked top or bottom frame rails or frame is cracked or broken.

2. Engine or transmission mounts are broken or missing.
3. Trailer hitch or pintle hook is not securely attached.

Reject if the pintle eye or trailer drawbar has any cracks or if any welding repairs have been made to the pintle eye.

4. Chains, cables, etc., used to attach a towed vehicle are not securely attached, or are broken, worn or abraded.
5. Fifth wheel does not lock in position or have a locking mechanism that is in proper working order.

NOTE: Reject if horizontal movement exceeds 1/2 inch between upper and lower fifth wheel halves.

6. Fifth wheel assembly system has any leak of fluid or air.
7. Fifth wheel has any broken, missing, or damaged parts; or is not securely attached to the frame. This includes fore and aft stops.

8. Trailer kingpin is not secure, or is broken, or worn so as to prevent secure fit in fifth wheel. *The upper coupler device is not securely attached.*

9. Any cracks, breaks or damaged parts in the stress or load bearing areas of a coupling device.

10. Trailer is not equipped with an emergency chain or chains.

NOTE: Fifth wheel assembly does not require emergency chains. A fifth wheel is defined as a device which interfaces with and couples to the upper coupler assembly of a semitrailer. The upper coupler assembly is a structure consisting of an upper coupler plate, kingpin and supporting framework which interfaces with and couples to a fifth wheel. Ball and socket connections also referred to as hitch and coupling connections are not fifth wheel assemblies and do not require safety chains.

11. *Reject if sliding trailer tandem or multi-axle assemblies do not lock in place or have worn, broken or missing parts.*

**19 VAC 30-70-500. Tires, wheels, rims.**

Inspect for and reject if:

1. Any tire is marked specifically for use other than on the highway, such as "For Farm Use Only," or "For Off-Highway Use Only," or any tire marked "Not for Steering Axle."
2. A radial tire is mismatched on the same axle with a bias ply tire or a bias belted tire.
3. Bias ply or bias belted tires are used on the rear axle when radial ply tires are used on the front axle. Except:
  - a. On a two-axle vehicle equipped with truck tires with 20-inch rim diameter and larger, bias or radial tires may be used on either axle if the vehicle has dual rear wheels, or is equipped with wide-base single tires.
  - b. Either bias or radial tires may be used on the steering axle of vehicles with three or more axles.
4. Bias tires and radial tires are mixed in a tandem-drive axle combination on a vehicle equipped with truck tires with 20-inch rim diameter and larger.
5. Any tire on the front wheel of a bus, truck or any tractor truck has a tread groove pattern of 4/32 inch or less when measured at any point on a major tread groove.
6. Any bus has regrooved, recapped or retreaded tires on the front wheels.
7. Any motor vehicle, trailer or semitrailer, except the dual wheels installed on motor vehicles having seats for more than seven passengers: (i) operated wholly within a municipality, or (ii) operated by urban and suburban bus lines, which are defined as bus lines operating over regularly scheduled routes and the majority of whose passengers use the buses for traveling a distance of not

exceeding 40 miles, measured one way, on the same day between their place of abode and their place of work, shopping areas, or schools, is equipped with a tire which has a tread depth measuring less than 2/32 of an inch when measured as follows: NOTE: The exemptions provided in clauses (i) and (ii) of this paragraph do not apply to buses owned or operated by any public school district, private school or contract operator of buses.

8. Measure in two adjacent tread grooves where tread is thinnest. If either of the grooves measure 2/32 of an inch or more, no further measurements are necessary and tread depth is satisfactory. Do not measure on tread wear indicators.

If both adjacent grooves measure less than 2/32 of an inch, the tire tread depth must be measured again at two additional equally spaced intervals around the circumference of the tire in a like manner as the first measurement. If the tread depth is less than 2/32 of an inch in two adjacent tread grooves at each of the equally spaced intervals, the tire must be rejected.

NOTE: Refer to Figures 1, 2, 3, and 4 in this section for illustrations of how to measure tire tread.

MEASURE WHERE THE TREAD IS THINNEST IN TWO ADJACENT TREAD GROOVES

FIGURE 1

IF THE DEPTH IS LESS THAN 2/32-INCH IN BOTH GROOVES MEASURE AT TWO ADDITIONAL EQUALLY SPACED INTERVALS

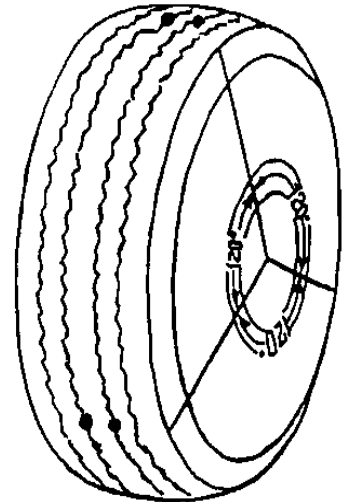

9. A tire equipped with tread wear indicators if found to have such indicators in contact with the pavement in any two adjacent grooves at three equally spaced intervals around the circumference of the tire. Refer to Figure 2.

---

# Proposed Regulations

---

REJECT IF THE TREAD WEAR INDICATORS ARE IN CONTACT WITH THE PAVEMENT IN ANY TWO ADJACENT GROOVES AT THREE EQUALLY SPACED LOCATIONS

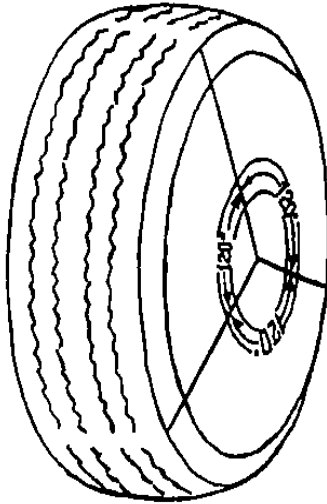

FIGURE 2

10. Any tire has a cut into the fabric to the extent a ply or belt material is exposed.
11. Any tire is worn so that the fabric or steel cord is visible.
12. Any tire has knots or bulges in its sidewalls or if there is evidence of a broken belt under the tread, or if the tread is separating from the fabric.
13. Any tire which has been recut or regrooved except commercial tires so designed and constructed to provide for acceptable and safe recutting and regrooving. Each tire that has been regrooved must be labeled with the

word "Regroovable" molded on or into the tire on both sidewalls in raised or recessed letters.

- ~~14. Any bolts, nuts or lugs are loose, missing or damaged.~~
- ~~15. Wheels are installed on the vehicle in a reversed position, except the wheels on vehicles which are reversed to perform a part of a dual wheel combination.~~
- ~~14. Any tire is flat or has an audible air leak.~~
- ~~15. Any tire so mounted or inflated that it comes into contact with its mate or any parts of the vehicle.~~
16. Rims, or lock rings or wheels are bent, cracked or damaged so as to affect safe operation of the vehicle. Reject if lug nut holes are elongated (out of round).
- ~~17. Any tire is flat or has an audible air leak.~~
- ~~18. Any tire so mounted or inflated that it comes into contact with its mate or any parts of the vehicle.~~
- ~~19. Any tire and rim size are not the same.~~
17. Any fasteners (both spoke and disc wheels) are loose, broken, cracked, stripped, missing or damaged or otherwise ineffective fasteners.
- ~~20. Commercial motor vehicles with a gross vehicle weight of 26,001 pounds or more have~~ 18. Any welded repair on aluminum wheel(s) on a steering axle or any welded repair (other than disc to rim attachment) on steel drive wheel(s) mounted on the steering axle.

FIGURE 3

ATTACHED TO BWCS NOTICE DATED 8/21/69

**HOW TO MEASURE TIRE TREAD**

When measuring tread depth, a gauge calibrated in 32nds of an inch should be used.

The gauge should be placed at the point in one of the treads indicated by an arrow. Depth reading should not be taken in treads marked with a circle, since these are classified as "minor" treads.

Persons taking measurements will have to use discretion in measuring tread depths not pictured here, however, measurements should not be made in treads which are obviously of a "minor" nature.

This guide merely depicts a number of the most common treads.

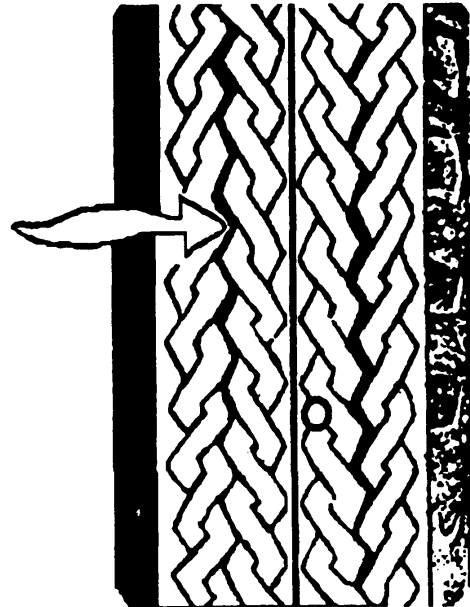

**MAJOR TREAD GROOVE**

Grooves in the tread design molded through the complete thickness of the tread rubber running around and/or across the tire surface



**MINOR TREAD GROOVE**  
Remaining tire tread design other than major tread groves.



**TIE-BAR**  
Molded rubber located in major tread groves for the purpose of connecting and supporting the tire treads.

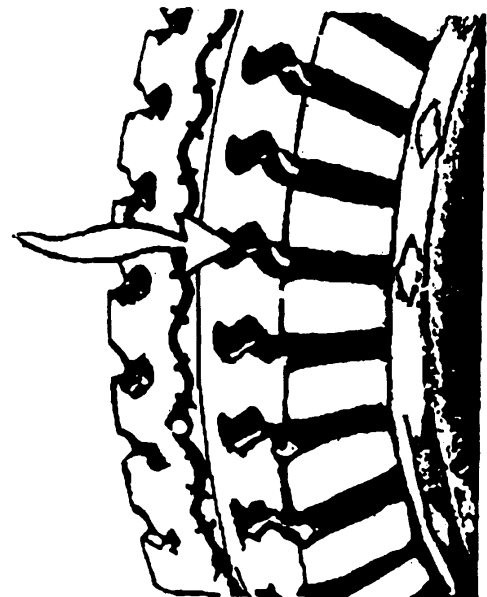
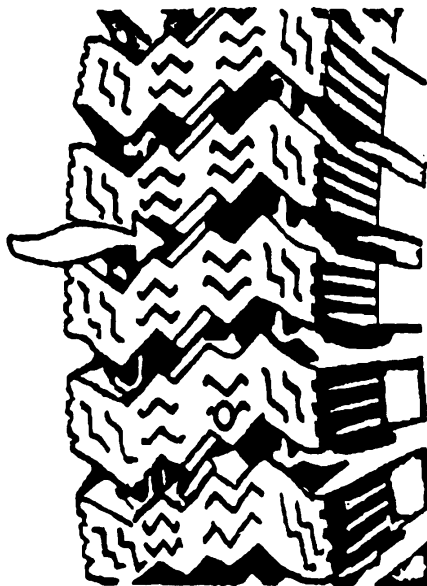

FIGURE 4



## 19 VAC 30-70-550. Clearance lamps and reflectors.

Inspect for and reject if:

1. Any motor vehicle, trailer, semitrailer or other vehicle is not equipped with clearance lamps if the vehicle is over seven feet wide or if any portion extends four inches or more outside the front fender line.

When a motor vehicle with a trailer attached is presented, the combination may be considered as one unit in meeting this requirement. If presented separately, the individual unit must meet these requirements except that any tractor-truck need not be equipped with rear red dimension or marker lamps.

2. Lamps and reflectors are not of an approved type or a lamp has been altered.

Reject if the lamps or reflectors have unapproved plastic covers, any other materials which are not original equipment or any colored material placed on or in front of lamps or reflectors.

3. Lenses on lamps on the front are not yellow or amber and lenses on lamps on the rear are not red or if a lens has a piece broken from it. A lens may have one or more cracks provided an off-color light does not project through the crack or cracks.

4. Wiring or electrical connections are defective, all filaments do not burn.

5. Two amber lamps are not mounted on the front and two red lamps on the rear, so as to indicate the extreme width of the body, and as high on the permanent body as practical, except that approved 180 degree lamps with yellow or amber lens may be mounted on the side of the vehicle at or as near the front as possible, or if the front is not the widest portion, the lamps may be installed on the side and as near that point as possible. And with the further exception that 180 degree lamps with red lens may be mounted on the side of the vehicle at or as near the rear as possible or if the rear is not the widest portion of the vehicle, the lamps may be installed on the side as near that point as possible.

6. Any vehicle equipped with three red identification lamps with the lamp centers spaced not less than six inches or more than 12 inches apart and installed as close as practicable to the top of the vehicle and as close as practicable to the vertical centerline of the vehicle may have the rear dimension or marker lamps required by paragraph 5 above mounted at any height but indicate as nearly as practicable the extreme width of the vehicle.

7. Dump trucks with a high lift body, concrete mixer trucks and other specially constructed vehicles may be equipped with the required clearance lamps not mounted on the extreme rear, provided such red lamps are clearly visible from the rear and provided further that two red reflectors of an approved type are mounted on the extreme rear. In unusual cases the rear lamp may

be mounted on the cab and another red reflex reflector placed on the extreme rear.

8. In addition to the required clearance lamps showing to the front and to the rear, a vehicle may be equipped with clearance lamps on the side of the vehicle. When such an installation is used, all of the clearance lamps on the side except the one at or near the rear must have an amber lens. The clearance lamps on the side at or near the rear must have a red lens.

9. Any vehicle covered by subdivision 1 of this section, except school buses, is not equipped with amber reflectors on the sides as near the front as practical, and red reflectors on the rear. The reflectors must be at least 24 1/2 inches and not more than 60 inches from the ground. No reflector can have a piece broken from its reflective surface, but may have one or more cracks.

10. Any combination of vehicles whose actual length exceeds 35 feet if the vehicles are not wide enough to have clearance lights, if the vehicle is not equipped with reflex reflectors of a type approved by the superintendent and mounted on the widest part of the towed vehicle so as to be visible from the front and sides of the vehicle. No reflector can have a piece broken from its reflective surface, but may have one or more cracks.

11. Any passenger vehicle is equipped with clearance lamps, unless such lamps are used to mark the extreme width of the vehicle or used as taxicab identification, or used as supplemental turn signals. (See 19 VAC 30-70-190, ~~paragraph B.~~)

12. Vehicles so constructed as to make compliance with the requirements of ~~paragraphs~~ subdivisions 1, 5, 7, 9 and 10 of this section impractical will be equipped with clearance lamps and reflectors at the most practical location to provide maximum visibility.

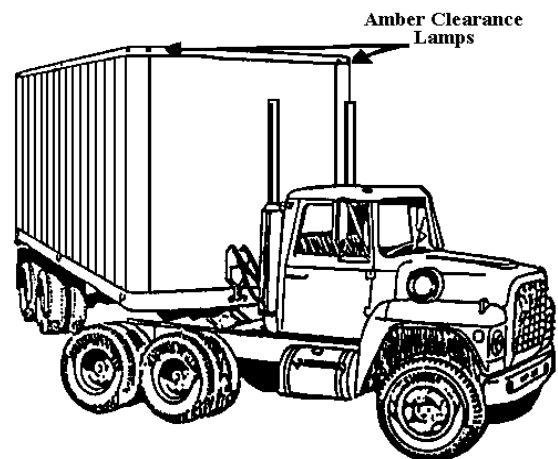

# Proposed Regulations

RED CLEARANCE LAMPS

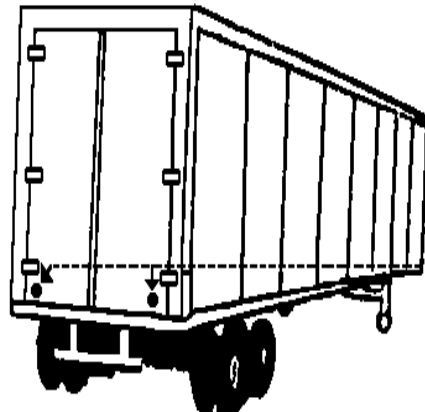
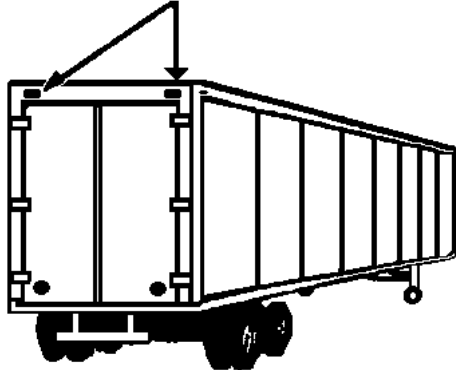

Red Reflectors --  
At least 24 15 inches and not more than 60 inches from the ground

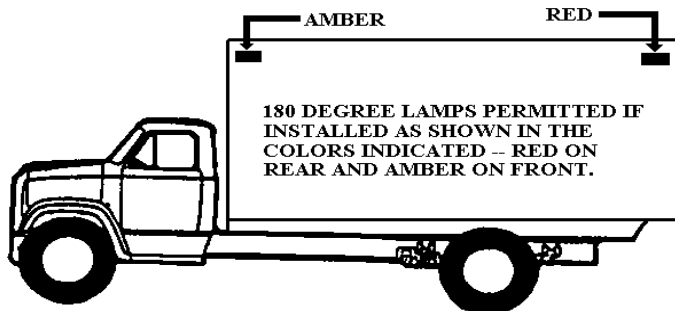

## 19 VAC 30-70-570. Permissible lighting equipment.

A. Any vehicle may be equipped with:

- ~~1. Magneto or acetylene lighting, if original equipment and if otherwise in conformity with these rules and regulations and Virginia statutes.~~
- ~~2. 1. Running board or courtesy lamps, of not over six candlepower.~~
- ~~3. 2. Vacant or destination signs, if a taxicab or bus.~~
- ~~4. 3. Identification lamps of approved type.~~
- ~~5. Front fender clearance jewels, if amber or yellow.~~
- ~~6. 4. Interior lights. (Not more than 15 candlepower.)~~

Exception: This does not apply to alternating, blinking or flashing colored emergency lights mounted inside law-enforcement vehicles or flashing, shielded red or red and white lights, mounted inside vehicles owned by members of volunteer fire companies, volunteer rescue squads or owned or used by professional firefighters.

~~7. Hood ornament light if of a type approved or permitted by the superintendent.~~

~~8. 5. A motor vehicle having a GVWR of ~~26,001~~ 10,001 pounds or more may be equipped with an illuminated bumper guide attached to each end of the front bumper, provided:~~

- a. The light thereon is amber in color and less than 6 candle-power.
- b. The light is wired to burn only in conjunction with the marker or clearance lamps on the vehicle.

~~9. 6. Any approved lamp in good working order when used for the purpose for which it was approved.~~

B. ~~Side Marker Lamps:~~ Side marker lamps are not required if *the vehicle(s) is over 30 feet in length*. If installed they must operate and be inspected. If the bulb, socket and wiring are removed from an individual lamp unit, the unit will not be considered during inspection.

Inspect for and reject if:

If equipped with three red identification lamps, the required clearance lamps may be mounted at any height so long as they indicate, as nearly as practicable, the extreme width of the vehicle.

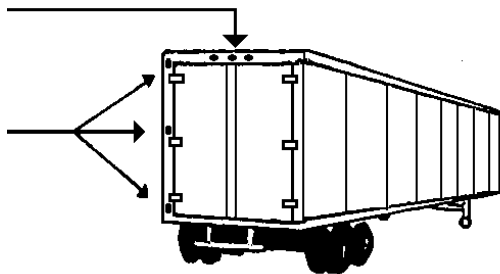

ILLUSTRATIONS FOR PROPER INSTALLATION OF REFLECTORS

Amber Reflector

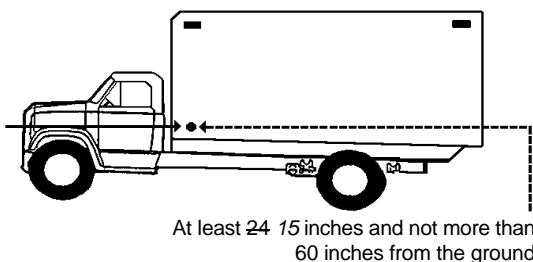



1. Lamps are not of an approved type, or do not comply with subsection A of this section.
2. Lamps are not installed on the permanent structure of the vehicle with one as far to the rear and one as far forward as practicable and at a location which is not less than 15 inches above the road surface when measured from the center of the lamp.
3. Lamps installed on the side to the rear do not project a red light and lamps installed on the front do not project an amber light.
4. Lens has a piece broken from it. The lens may have one or more cracks provided no off-color light projects through the crack or cracks.
5. Wiring or electrical connections are defective or filaments do not burn.
6. Any vehicle has unapproved lens or plastic covers, any other materials which are not original equipment or any colored material placed on or in front of permissible lighting equipment.

## 19 VAC 30-70-580. Glazing.

A. Motor vehicles may be inspected without windshields, side glasses, or any kind of glazing except that any motor vehicle other than a motorcycle which was manufactured, assembled, or reconstructed after July 1, 1970, must be equipped with a windshield. If glass or other glazing is installed, it must be inspected. If no windshield is installed, see 19 VAC 30-70-50, ~~subsection C~~, for location of the sticker.

### B. Inspect for and reject if:

1. Any motor vehicle manufactured or assembled after January 1, 1936, or any bus or school bus manufactured or assembled after January 1, 1935, is not equipped throughout with safety glass, or other safety glazing material. (This requirement includes slide-in campers used on pickups or trucks, caps, or covers used on pickup trucks, motor homes, and vans.)
2. Any safety glass or glazing used in a motor vehicle is not of an approved type and properly identified. (Replacement safety glass installed in any part of a vehicle other than the windshield need not bear a trademark or name, provided the glass consists of two or more sheets of glass separated by a glazing material, and provided the glass is cut from a piece of approved safety glass, and provided the edge of the glass can be observed.)
3. Any glass at any location where glass is used is cracked or broken so that it is likely to cut or injure a person in the vehicle.
4. Windshield has any cloudiness more than three inches above the bottom, one inch inward from the outer borders, one inch down from the top, or one inch inward from the center strip. The bottom of the windshield shall be defined as the point where the top of the dash contacts the windshield.

5. Any distortion or obstruction that interferes with a driver's vision.

- a. Any hood scoop installed on any motor vehicle manufactured for 1990 or earlier model year cannot exceed 2¼ inches high at its highest point measured from the junction of the dashboard and the windshield.
- b. Any hood scoop installed on any motor vehicle manufactured for the year 1991 or subsequent model year cannot exceed 1½ inches high at its highest point measured from the junction of the dashboard and the windshield.

6. Windshield glass, on the driver's side, has any scratch more than ¼ inch in width and six inches long within the area covered by the windshield wiper blade, excluding the three inches above the bottom of the windshield.

EXCEPTION: Do not reject safety grooves designed to clean wiper blades if the grooves do not extend upward from the bottom of the windshield more than six inches at the highest point.

7. There is a pit, chip, or star crack larger than ~~4½ inches~~ ¼ inch in diameter at any location in the windshield above the ~~three-inch line at the bottom~~ topmost portion of the steering wheel except the two-inch border at the top and the one-inch border at each side.

8. At any location ~~in the windshield above the three-inch line at the bottom there is more than one crack from the same point if at least one of the cracks is more than 1½ inches in length. There is any crack that weakens the windshield so that one piece may be moved in relation to the other. (If there is more than one crack running from a star crack that extends above the three-inch line, the windshield shall be rejected.)~~ above the topmost portion of the steering wheel excluding a two-inch border at the top and one-inch border at the sides there is:

- a. Any crack over ¼ inch in width.
- b. Any crack ¼ inch or less in width intersected by another crack.
- c. Any damage area ¾ inch or less in diameter if within three inches of any other damage area.

9. Any sticker is on the windshield other than an official one required by law, or permitted by the Superintendent. Authorization is hereby granted to stickers measuring not more than 2½ inches in width and four inches in length to be placed in the blind spot behind the rear view mirror. Any sticker required by law must be placed adjacent to the official inspection sticker and must not extend upward more than three inches from the bottom of the windshield; except, on vehicles operating in interstate commerce, under rules and regulations of ICC, stickers required by law must not extend upward more than 4½ inches from the bottom of the windshield. A valid Commercial Vehicle Safety Alliance or motor

---

# Proposed Regulations

---

carrier inspection sticker issued by certified law-enforcement agencies not exceeding three inches in height and two inches in width may be placed at the lower right corner of the windshield on trucks and tractor-trucks having a GVWR of 26,001 pounds or more.

Any sticker required by the laws of any other state or District of Columbia and displayed upon the windshield of a vehicle submitted for inspection in this state is permitted by the superintendent, provided the vehicle is currently registered in that jurisdiction, the sticker is displayed in a manner designated by the issuing authority and has not expired. This includes vehicles with dual registration, i.e., Virginia and the District of Columbia.

10. Stickers or decals used by counties, cities and towns in lieu of license plates may be placed on the windshield without further authority. Except on privately owned yellow school buses, the sticker or decal shall be placed on the windshield adjacent to the right side of the official inspection sticker. The top edge of the sticker or decal shall not extend upwards more than three inches from the bottom of the windshield. The left side edge adjacent to the official inspection sticker shall not be more than  $\frac{1}{4}$  inch from the right edge of the official inspection sticker when looking through the windshield from inside the vehicle. However, at the option of the motor vehicle owner, the sticker or decal may be affixed to the upper edge of the center of the windshield. (Any expired sticker or decal present on the windshield at the time of inspection shall be removed, excluding a rejection sticker.) On privately owned yellow school buses, the sticker or decal shall be placed on the windshield adjacent to the left side of the official inspection sticker, and not more than  $\frac{1}{4}$  inch from the official inspection sticker when looking through the windshield from inside the vehicle. The top edge of the sticker shall not extend upward more than three inches from the bottom of the windshield.

11. ~~Sunshading~~ Any material attached to the windshield ~~extends more than three inches downward from the top of the windshield~~, unless authorized by a medical waiver certificate, *or replacement of the sunshield in the uppermost area as installed by the manufacturer of the vehicle.*

NOTE: ~~Sunshading~~ Any material on windshield displaying words, lettering, numbers or pictures is not approved and is not permitted.

12. Any sunscreening material is scratched, distorted, wrinkled or obscures or distorts clear vision through the glazing.

13. Front side windows have cloudiness above three inches from the bottom of the glass, or other defects that affect the driver's vision or one or more cracks which permit one part of the glass to be moved in relation to another part. Wind silencers, breezes or

other ventilator adaptors are not made of clear transparent material.

14. Glass in the left front door cannot be raised or lowered easily so a hand signal can be given. (This does not apply to vehicle equipped with approved turn signals which were not designed and/or manufactured for left front glass to be lowered.) If either front door has the glass removed and material inserted in place of the glass which could obstruct the driver's vision.

Exception: Sunscreening material is permissible if the vehicle is equipped with a mirror on each side.

15. Any sticker or other obstruction is on either front side window, rear side windows, or rear windows. (The price label, fuel economy label and the buyer's guide required by federal statute and regulations to be affixed to new/used vehicles by the manufacturer shall normally be affixed to one of the rear side windows.) If a vehicle only has two door windows, the labels may be affixed to one of these windows. If a vehicle does not have any door or side windows the labels may be temporarily affixed to the right side of the windshield until the vehicle is sold to the first purchaser.

NOTE: A single sticker no larger than 20 square inches in area, if such sticker is totally contained within the lower five inches of the glass in the rear window or a single sticker or decal no larger than 10 square inches located in an area not more than three inches above the bottom and not more than eight inches from the rearmost edge of either front side window, is permissible and should not be rejected.

Do not reject a tractor truck having a gross vehicle weight rating of 26,001 pounds or more equipped with one optically grooved clear plastic wide angle lens affixed to the right front side window. Such wide angle lens shall not extend upward from the bottom of the window opening more than six inches or backward from the front of the window opening more than eight inches.

16. Rear window is clouded or distorted so that the driver does not have a view 200 feet to the rear.

EXCEPTIONS: The following are permissible if the vehicle is equipped with a mirror on each side:

a. There is attached to one rear window of such motor vehicle one optically grooved clear plastic right angle rear view lens, not exceeding 18 inches in diameter in the case of a circular lens or not exceeding 11 inches by 14 inches in the case of a rectangular lens, which enables the operator of the motor vehicle to view below the line of sight as viewed through the rear window.

b. There is affixed to the rear side windows, rear window or windows of such motor vehicle any sticker or stickers, regardless of size.

c. There is affixed to the rear side windows, rear window or windows of such motor vehicle a single

layer of ~~any approved~~ sunshading material, ~~VAT-1, VAT-2 and VAT-3.~~

d. Rear side windows, rear window or windows is clouded or distorted.

**19 VAC 30-70-680. Fuel system.**

Inspect for and reject if:

1. Any part of the fuel system is not securely fastened.
2. There is fuel leakage at any point in ~~the~~ *any* fuel system.
3. ~~The~~ *Any* fuel tank filler cap is missing.
4. ~~The~~ *Any* fuel tank crossover lines are not protected *if they extend more than two inches below the bottom of the tank or sump.*
5. Any part of the fuel system comes in contact with the exhaust system.

VA.R. Doc. No. R98-51; Filed June 3, 1998, 11:55 a.m.



---

# FINAL REGULATIONS

---

For information concerning Final Regulations, see Information Page.

---

## Symbol Key

Roman type indicates existing text of regulations. *Italic type* indicates new text. Language which has been stricken indicates text to be deleted. [Bracketed language] indicates a change from the proposed text of the regulation.

---

## TITLE 8. EDUCATION

### STATE BOARD OF EDUCATION

**REGISTRAR'S NOTICE:** During its January 8, 1998 meeting, the State Board of Education approved final regulations entitled "Licensure Regulations for School Personnel" (8 VAC 20-21-10 et seq.), except for 8 VAC 200-21-430, Special education: mild-moderate disabilities K-12 and 8 VAC 20-21-440, Special education: moderate-severe disabilities K-12, which were proposed in 13:25 VA.R. 3323-3325 September 1, 1997. The board deferred action on the two sections listed above because, during the comment period, concerns were expressed relative to discontinuing the endorsement in special education-learning disabilities. On February 26, 1998, the Board of Education approved a substitute proposal in the endorsement areas of special education-learning disabilities K-12, special education-mental retardation K-12, special education-emotionally disturbed K-12 which were proposed in 14:14 VA.R. 2061-2065 March 30, 1998. The agency solicited comments on the repropoed regulations until April 30, 1998. On May 26, 1998, the State Board of Education approved the sections as proposed with one exception in 8 VAC 20-21-425.

**Title of Regulation:** 8 VAC 20-20-10 et seq. **Regulations Governing the Licensure of School Personnel (repealing 8 VAC 20-20-750, 8 VAC 20-20-770, 8 VAC 20-20-780 and 8 VAC 20-20-790).**

**Title of Regulation:** 8 VAC 20-21-10 et seq. **Licensure Regulations for School Personnel (adding 8 VAC 20-21-425, 8 VAC 20-21-430, 8 VAC 20-21-435, 8 VAC 20-21-440, and 8 VAC 20-21-445).**

**Statutory Authority:** § 22.1-298 of the Code of Virginia.

**Effective Date:** July 22, 1998.

#### **Summary:**

*The special education core competencies and the requirements for emotional disturbance, learning disabilities, mental retardation, and severe disabilities are aligned with the Standards of Learning. The requirements also include competencies and endorsement requirements for each teaching area; therefore, these requirements are compatible with the other teaching areas in the new Licensure Regulations for School Personnel. These requirements will be incorporated into the new licensure regulations.*

*Currently, Virginia offers categorical endorsements in special education. The proposal will continue the separate endorsements in emotional disturbance,*

*learning disabilities, mental retardation, and severe disabilities. Core competencies are required for each of these special education endorsements in addition to the competencies in the specific area of disability.*

**Summary of Public Comments and Agency's Response:** A summary of comments made by the public and the agency's response may be obtained from the promulgating agency or viewed at the office of the Registrar of Regulations.

**Agency Contact:** Copies of the regulation may be obtained from Dr. Thomas A. Elliott, Assistant Superintendent for Compliance, Department of Education, P.O. Box 2120, Richmond, VA 23218-2120, telephone (804) 371-2522.

**8 VAC 20-21-425. Core competencies for special education: emotional disturbance K-12, learning disabilities K-12, mental retardation K-12, and severe disabilities K-12.**

*The program in special education is designed to ensure through course work and field experiences in a variety of settings that the candidate has demonstrated the following core competencies to prepare children and youth for participation in the general education curriculum and within the community to the maximum extent possible. The candidate must also complete the competencies in at least one endorsement area of special education and those required under professional studies, including reading and language acquisition.*

1. Knowledge of the foundation for educating students with disabilities, including:

a. Historical perspectives, models, theories, philosophies, and trends that provide the basis for special education practice;

b. Characteristics of children and youth with disabilities relative to age, varying levels of severity, and developmental differences manifested in cognitive, linguistic, physical, psychomotor, social, or emotional functioning;

c. Normal patterns of development (i.e., physical, psychomotor, cognitive, linguistic, social, emotional development and their relationship to the various disabilities);

d. Medical aspects of disabilities;

e. The dynamic influence of the family system and cultural/environmental milieu and related issues pertinent to the education of students with disabilities;

f. Educational implications of the various disabilities; and

- g. Understanding of ethical issues and the practice of accepted standards of professional behavior.*
  - 2. An understanding and application of the legal aspects and regulatory requirements associated with identification, education, and evaluation of students with disabilities, including:*
    - a. Legislative and judicial mandates related to education and special education (e.g., the Individuals with Disabilities Education Act (IDEA), § 504 of the Rehabilitation Act of 1973, and the Americans with Disabilities Act);*
    - b. Current regulations governing special education (e.g., individualized education program (IEP) development; disciplinary practices, policies, and procedures; and alternative placements/programs in schools); and*
    - c. "Rights and responsibilities" of parents, students, teachers, and schools as they relate to individuals with disabilities and disability issues.*
  - 3. An understanding and application of the foundation of assessment and evaluation related to best special education practice, including:*
    - a. Ethical issues and responsibilities in the assessment of individuals with disabilities;*
    - b. Procedures for screening, prereferral, referral, and eligibility determinations;*
    - c. Factors that may influence assessment findings such as cultural, behavioral, and learning diversity;*
    - d. Administration, scoring, and interpretation of commonly used individual and group instruments, including norm-referenced, criterion-referenced, and curriculum-based measures as well as task analysis, observation, portfolio, and environmental assessments; and*
    - e. Synthesis and interpretation of assessment findings for eligibility, program planning, and program evaluation decisions.*
  - 4. An understanding and application of service delivery, curriculum, and instruction of students with disabilities including:*
    - a. Classroom organization and curriculum development;*
    - b. Scope and sequence of the general education curriculum;*
    - c. Complex nature of language acquisition and reading (see reading competencies in 8 VAC 20-21-170 4 b, Professional studies requirements);*
    - d. Alternative ways to teach content material including curriculum adaptation and curriculum modifications;*
  - e. Procedures to develop, provide, and evaluate instruction consistent with students' individual needs;*
  - f. Strategies to promote successful integration of students with disabilities with their nondisabled peers;*
  - g. Use of technology to promote student learning; and*
  - h. Structure and organization of general education classrooms and other instructional settings representing the continuum of special education services (to include field experiences).*
  - 5. An understanding and application of classroom management techniques and individual interventions, including techniques which:*
    - a. Promote emotional well-being and teach and maintain behavioral conduct and skills consistent with norms, standards, and rules of the educational environment;*
    - b. Address diverse approaches based upon behavioral, cognitive, affective, social and ecological theory and practice;*
    - c. Provide positive behavioral supports; and*
    - d. Are based on functional [ analysis assessment ] of behavior.*
  - 6. The ability to prepare students and work with families to promote successful student transitions throughout the educational experience to include post-secondary training, employment, and independent living which addresses an understanding of long-term planning, career development, life skills, community experiences and resources, self-advocacy and self-determination, guardianship, and legal considerations.*
  - 7. Skills in consultation, case management, and collaboration, including:*
    - a. Coordination of service delivery with related service providers, general educators, and other professions in collaborative work environments;*
    - b. Preparing, managing, and monitoring paraprofessionals;*
    - c. Involvement of families in the education of their children with disabilities; and*
    - d. Cooperating with community agencies and other resource providers.*
- 8 VAC 20-21-430. Special education: emotional disturbance K-12.**
- A. The program in emotional disturbance K-12 will ensure through course work and field experiences in a variety of settings that the candidate seeking endorsement in emotional disturbance has demonstrated the special education core competencies specified in 8 VAC 20-21-425 and the specific competency requirements for emotional disturbance specified in this section.*

---

# Final Regulations

---

The candidate must demonstrate the following competencies:

1. Knowledge and understanding of the characteristics and needs of individuals with emotional disturbance. The characteristics should be considered in light of specific age-span/developmental issues and definitions related to cognitive functioning, multicultural influences, emotional adjustment, social development (e.g., the definitions in IDEA and the National Mental Health/Special Education Coalition definition).

2. Use of assessment, evaluation and other information to develop and implement individual educational programs and group instruction for individuals with emotional disturbance to facilitate integration of these students into the continuum of services, including the ability to:

a. Integrate academic instruction, affective education, and behavior management for individual students or groups of students to prevent inappropriate behavior;

b. Write and implement individualized education plans (IEP) to include positive behavioral interventions plans;

c. Delineate and apply the goals and intervention strategies and procedures related to a variety of theoretical approaches, including social learning theory;

d. Use a variety of positive strategies for the purpose of controlling targeted behaviors;

e. Develop and implement systematic behavior management plans for students using a variety of behavioral principles, including the ability to use appropriate and effective nonabusive, nonphysical, nonviolent punishment procedures in the context of a predominantly positive program;

f. Define and use skills in problem solving and conflict resolution to manage student behavior and social interaction skills;

g. Identify and apply instructional and remedial methodologies; and

h. Use self-protective strategies.

3. Completion of supervised classroom experiences with students with emotional disturbance K-12.

**B. Endorsement requirements.** The candidate must:

1. Have graduated from an approved program in special education: emotional disturbance;

2. Have completed a major in special education: emotional disturbance K-12 or 27 semester hours in the education of students with emotional disturbance with course work in the following: foundations/legal/ethical aspects of special education, psychoeducational assessment, reading/language acquisition, structure and organization of the continuum of services including the

general education classroom, scope and sequence of the general education curriculum, behavior management, transition, consultation, characteristics of individuals with emotional disturbance, instructional programming and methods for students with emotional disturbance consistent with the above competencies. In addition the candidate must have completed supervised classroom experience with students with emotional disturbance. One year of successful, full-time teaching experience with students with emotional disturbance in an accredited public or nonpublic school may be accepted in lieu of student teaching; or

3. Possess a valid Virginia teaching license with an endorsement in at least one area of special education and complete course work and field experiences in a variety of settings, demonstrating the specific competency requirements in special education: emotional disturbance K-12. One year of successful, full-time teaching experience with students with emotional disturbance in an accredited public or nonpublic school may be accepted in lieu of student teaching.

## **8 VAC 20-21-435. Special education: learning disabilities K-12.**

A. The program in learning disabilities K-12 will ensure through course work and field experiences in a variety of settings that the candidate seeking endorsement in learning disabilities has demonstrated the special education core competencies specified in 8 VAC 20-21-425 and the specific competency requirements for learning disabilities specified in this section.

The candidate must demonstrate the following competencies:

1. Knowledge and understanding of the theories, characteristics, etiology and needs of students with specific learning disabilities. These include:

a. Related disabilities, such as attention deficit disorders;

b. Specific age-span/developmental issues;

c. Cognitive functioning, including intelligence, perception, neurobiology, linguistics, memory and thinking;

d. Levels of severity;

e. Multicultural influences;

f. Social/emotional aspects, including social imperceptiveness, juvenile delinquency, and personal control attributes; and

g. Medical aspects, including medication, nutrition, genetics, and neurology.

2. Knowledge of a wide range of assessment procedures for students with learning disabilities to assist in instruction and life planning. These include:

a. Use of assessment procedures to identify individual instructional needs in areas including reading, receptive and expressive language, written language and mathematics; and

b. Ability to interpret educational assessment results to parents, students, and other professionals.

3. Use of assessment, evaluation, and other information to develop and implement individualized educational programs (IEP) and group instruction for individuals with learning disabilities within the continuum of services. This includes the ability to:

a. Teach and remediate skills in reading, receptive and expressive language, pragmatic language, written language, social skills, and mathematics;

b. Provide explicit instruction of reading and spelling in a systematic and cumulative manner based upon understanding the structure and development of the English language at the sound, syllable, word and sentence levels; and understanding the relationship between spoken and written language, including the understanding and the application of phonology, phonological awareness, sound-symbol association, syllable patterns, morphology English orthography, and grammatical structures and the relationship between teaching written expression and reading comprehension;

c. Apply developmental and remedial methodologies, including systematic instruction, multisensory approaches, cognitive learning strategies, study skills, accommodations for diverse learning styles, and technology; and

d. Design alternative ways to teach content material to students with learning disabilities, including adapting and modifying the curriculum, and the selection of specialized instructional materials appropriate to the needs of the student with learning disabilities.

4. Completion of supervised classroom experiences with students with learning disabilities in grades K-12.

**B. Endorsement requirements. The candidate must:**

1. Have graduated from an approved teacher preparation program in special education: learning disabilities;

2. Have completed a major in special education: learning disabilities or 27 semester hours in the education of students with learning disabilities with course work in each of the following: foundations/legal/ethical aspects of special education, psychoeducational assessment, reading/language acquisition, structure and organization of the continuum of special education services including the general education classroom, scope and sequence of the general education curriculum, behavior management, transition, consultation, characteristics of individuals with learning disabilities, and instructional and remedial

programs and methods for learning disabilities consistent with the above competencies. In addition a candidate must have completed a supervised classroom experience with students with learning disabilities. One year of successful, full-time teaching experience with students with learning disabilities in an accredited public or nonpublic school may be accepted in lieu of student teaching; or

3. Possess a valid Virginia teaching license with an endorsement in at least one area of special education and complete course work and field experiences in a variety of settings, demonstrating the specific competency requirements in learning disabilities K-12. One year of successful, full-time teaching experience with students with learning disabilities in an accredited public or nonpublic school may be accepted in lieu of student teaching.

## **8 VAC 20-21-440. Special education: mental retardation K-12.**

A. The program in mental retardation K-12 will ensure through course work and field experiences in a variety of settings that the candidate seeking endorsement in mental retardation has the special education core competencies specified in 8 VAC 20-21-425 and the specific competency requirements for mental retardation specified in this section.

The candidate must demonstrate the following competencies:

1. Knowledge and understanding of the definition, characteristics and needs of students with mental retardation. These include:

- a. Cognitive functioning;
- b. Multicultural influences;
- c. Emotional adjustment;
- d. Social development;
- e. Language development;
- f. Adaptive behavior; and
- g. Medical/health issues.

2. Use of alternative assessment, evaluation, and other information to develop and implement individual educational programs and group instruction for individuals with mental retardation to facilitate integration of these students into the continuum of services. This includes:

- a. Proficiency in adapting age-appropriate curriculum to facilitate instruction within the general education setting, to include partial participation of students in tasks;
- b. Ability to teach skills in academic areas including reading, receptive and expressive language, and mathematics and to facilitate the transfer and generalization to functional context;

---

# Final Regulations

---

c. Ability to utilize research-supported instructional strategies and practices, including functional embedded skills approach, community-based instruction, task analysis, multisensory, study skills, diverse learning styles, and concrete/manipulative techniques;

d. Ability to teach culturally responsive functional skills relevant to independence in the community, personal living, employment, self-advocacy and self determination; and

e. Ability to evaluate and use assistive technology for communication, independent living, and the assessment of student needs.

3. Completion of supervised classroom experiences with students with mental retardation K-12.

B. Endorsement requirements. The candidate must:

1. Have graduated from an approved program in special education: mental retardation;

2. Have completed a major in special education: mental retardation K-12 or 27 semester hours in the education of students with mental retardation with course work in the following: foundations/legal/ethical aspects of special education, psychoeducational assessment, reading/language acquisition, structure and organization of the continuum of services including the general education classroom, scope and sequence of the general education curriculum, behavior management, transition, consultation, characteristics of individuals with mental retardation, instructional programming and methods for students with mental retardation consistent with the above competencies. In addition the candidate must have completed a supervised classroom experience with students with mental retardation. One year of successful, full-time teaching experience with students with mental retardation in an accredited public or nonpublic school may be accepted in lieu of student teaching; or

3. Possess a valid Virginia teaching license with an endorsement in at least one area of special education and complete course work and field experiences in a variety of settings, demonstrating the specific competency requirements in special education: mental retardation K-12. One year of successful, full-time teaching experience with students with mental retardation in an accredited public or nonpublic school may be accepted in lieu of student teaching.

## **8 VAC 20-21-445. Special education: severe disabilities K-12.**

A. The program in severe disabilities K-12 will ensure through course work and field experience in a variety of settings that the candidate seeking endorsement in severe disabilities has demonstrated the special education core competencies specified in 8 VAC 20-21-425 and the specific

competency requirements for severe disabilities K-12 specified in this section.

The candidate must demonstrate the following competencies:

1. Knowledge and understanding of the characteristics and needs of individuals with severe disabilities. This includes the emotional, social, neurobiological, linguistic, medical and educational aspects of severe disabilities based upon current research, best practice and legal considerations.

2. The use of alternative assessment, evaluation and other information to develop and implement individual educational programs and group instruction for individuals with severe disabilities, including:

a. The ability to develop, plan, and teach a functional and age-appropriate curriculum including skills in self-care, independent living, leisure/recreation, school and community use, functional academics, and vocational planning;

b. Knowledge and proficiency in implementing direct and systematic instruction;

c. Knowledge of unique physical needs, including positioning and handling, medical considerations, seizures, etc.;

d. Proficiency in adapting age-appropriate curriculum to facilitate instruction within the general education setting, to include partial participation of students in tasks and skills facilitating collaboration and support from peers with and without disabilities;

e. The ability to select and use augmentative and alternative communication methods and systems;

f. The ability to select and use assistive technology to facilitate learning and independent living; and

g. An understanding of the impact of speech-language development on behavior and social interactions.

3. The ability to implement and evaluate group management techniques and individual interventions that maintain emotional, behavioral, and social skills consistent with the norms, standards, and rules of the educational environment. These techniques and interventions include:

a. Identifying the origin and function of the behavior;

b. Identifying and teaching alternative behaviors;

c. Developing positive behavior support plans;

d. Developing schedules and routines;

e. Applying behavioral research; and

f. Providing positive behavioral support.

4. Complete supervised classroom experience with students with severe disabilities K-12.



B. Endorsement requirements. The candidate must:

1. Have graduated from an approved program in special education: severe disabilities;
2. Have completed a major in special education: severe disabilities K-12 or 27 semester hours in the education of students with severe disabilities with course work in the following: foundations/legal/ethical aspects of special education, psychoeducational assessment, reading/language acquisition, structure and organization of the continuum of special education services including the general education classroom, scope and sequence of the general education curriculum, behavior management, transition, consultation, characteristics of individuals with severe disabilities, instructional programming and methods for severe disabilities consistent with the above competencies. In addition the candidate must have completed a supervised classroom experience with students with severe disabilities. One year of successful, full-time teaching experience with students with severe disabilities in an accredited public or nonpublic school may be accepted in lieu of student teaching; or
3. Possess a valid Virginia teaching license with an endorsement in at least one area of special education and complete course work and field experiences in a variety of settings, demonstrating the specific requirements in severe disabilities K-12. One year of successful, full-time teaching experience with students with severe disabilities in an accredited public or nonpublic school may be accepted in lieu of student teaching.

VA.R. Doc. No. R97-729; Filed June 3, 1998, 12:27 p.m.

**TITLE 16. LABOR AND EMPLOYMENT**

**GOVERNOR'S EMPLOYMENT AND TRAINING DEPARTMENT**

**REGISTRAR'S NOTICE:** The following regulation filed by the Governor's Employment and Training Department is exempt from the Administrative Process Act in accordance with § 9-6.14:4.1 B 4 of the Code of Virginia, which exempts regulations relating to grants of state or federal funds or property.

**Title of Regulation:** 16 VAC 10-20-10 et seq. JTPA (Job Training Partnership Act) Requirements (amending 16 VAC 10-20-10, 16 VAC 10-20-20, 16 VAC 10-20-30, 16 VAC 10-20-40, 16 VAC 10-20-80, 16 VAC 10-20-110, 16 VAC 10-20-140, 16 VAC 10-20-150, 16 VAC 10-20-160, 16 VAC 10-20-170, 16 VAC 10-20-190, 16 VAC 10-20-200, 16 VAC 10-20-240, 16 VAC 10-20-280, 16 VAC 10-20-300; adding 16 VAC 10-20-275; repealing 16 VAC 10-20-50, 16 VAC 10-20-60, 16 VAC 10-20-70, 16 VAC 10-20-90,

16 VAC 10-20-100, 16 VAC 10-20-180, 16 VAC 10-20-210, 16 VAC 10-20-220, 16 VAC 10-20-230, 16 VAC 10-20-250, 16 VAC 10-20-260, 16 VAC 10-20-270, 16 VAC 10-20-290, and 16 VAC 10-20-310 through 16 VAC 10-20-460).

Statutory Authority: § 2.1-708 of the Code of Virginia.

Effective Date: July 1, 1998.

Summary:

The amendments to this regulation (i) incorporate language relating to area agencies on aging, (ii) provide for consistency and clarity in the use of terms, and (iii) eliminate language which places requirements on SDA contractors and subcontractors and places responsibilities for the management and oversight on SDAs and area agencies on aging. Requirements that merely restated federal regulations or contractual obligations were deleted.

Agency Contact: Copies of the regulation may be obtained from Louise Armstrong, Regulatory Coordinator, Governor's Employment and Training Department, Theater Row Building, 730 East Broad Street, 9th Floor, Richmond, VA 23219, telephone (804) 786-2508.

**16 VAC 10-20-10. Definitions.**

The following words and terms, when used in this chapter, shall have the following meanings, unless the context clearly indicates otherwise:

"AAA" means Area Agency on Aging that administers the Older Worker Program authorized under § 204(d) of JTPA.

~~"Contractor" means a person, entity or organization who receives JTPA funds from an SDA to provide services or training or both to participants. The term shall include entities which receive funds and are deemed to be employers of participants, or who provided customized training to participants who, upon successful completion of that training, are employed by the entity in accordance with an agreement with the SDA.~~

"DOL" means the United States Department of Labor.

~~"EDWAA" means the Economic Dislocation and Worker Adjustment Assistance Act, 29 USCS s 1501nt., EDWAA amends Title III of JTPA.~~

"GETD" means the Governor's Employment and Training Department.

~~"GJTCC" means the Governor's Job Training Coordinating Council.~~

"JTPA" means the Job Training Partnership Act, Public Law 97-300, 29 USCS §§ 1501 et seq., as amended.

~~"PIC" means the Private Industry Council established in each service delivery area.~~

~~"SDA" means the administrative entity, the grant recipient, the PIC, and the local elected officials that cooperatively manage the JTPA Title II programs and activities in a geographic area which has been designated by the Governor~~

---

# Final Regulations

---

as a service delivery area. For the purposes of this chapter, the term "SDA" shall also include the substate grantee which administers the Title III program selected to administer the JTPA Title II program by the Private Industry Council and the local elected officials in the geographic service delivery area that was designated by the Governor pursuant to § 101 (a) (4) of the JTPA. As used in this chapter, the term also includes the substate grantee that administers the JTPA Title III program in the service delivery area.

## 16 VAC 10-20-20. Purpose and authority.

These regulations are promulgated by the Governor's Employment and Training Department pursuant to the authority granted by § 2.1-708 of the Code of Virginia. These regulations supplement the requirements of the Job Training Partnership Act (PL 97-300), as amended by the Job Training Reform Amendments of 1992 (PL 102-367) and the Economic Dislocation and Worker Adjustment Assistance Act (PL 97-300, as amended) and the implementing regulations (20 CFR Parts 626 through 631) issued by the United States Department of Labor. Therefore, these regulations must be read in concert with the Job Training Partnership Act, as amended, the Economic Dislocation and Worker Adjustment Assistance Act, as amended and the regulations (20 CFR Parts 626 through 631) of the United States Department of Labor.

## 16 VAC 10-20-30. Evaluation of regulations.

A. The GETD will evaluate the effectiveness of these regulations on an on-going basis. Interested parties are invited to submit comments and recommendations concerning the regulations to the Research, Policy and Evaluation Unit of the GETD.

B. Every two years following the adoption of these regulations, the GETD will provide for and announce a procedure to review, evaluate, and, as necessary, amend these regulations. The procedure will include a process by which the public will be invited to recommend, in writing, revisions to the regulations and will be afforded an opportunity to review and comment on any proposed revisions.

## 16 VAC 10-20-40. Conflicts and severability.

Any provision contained in these regulations which that is found to be unlawful or is superseded by action of DOL shall be severable from the remaining provisions.

## 16 VAC 10-20-50. Identification of SDA requirements. (Repealed.)

~~If an SDA imposes a requirement relating to the administration and operation of programs funded by the Act, the SDA shall identify the requirement as an SDA-imposed requirement. If an SDA imposes a requirement based on the SDA's interpretation of any federal law, regulation, or guideline or any state regulation, policy or guideline, the SDA shall identify the requirement as an SDA-imposed requirement.~~

## 16 VAC 10-20-60. Applicability of state laws. (Repealed.)

~~With respect to placement of participants in work training situations, SDAs, contractors and agencies administering JTPA participant activities shall be guided by:~~

- ~~1. The standards contained in the Occupational Safety and Health Standards for General Industry (29 CFR Part 1910) inclusive of the "Virginia Preface to OSHA Standards Book for General Industry";~~
- ~~2. Virginia Child Labor Laws as contained in Chapter 5 (s. 40.1-78 et seq.) of Title 40.1 of the Code of Virginia; and~~
- ~~3. Virginia Worker's Compensation Act as contained in Title 65.2 of the Code of Virginia.~~

## 16 VAC 10-20-70. Clarification of JTPA and related regulations. (Repealed.)

~~A. Pursuant to the agreement for the implementation of JTPA between the Governor of Virginia and the U.S. Secretary of Labor, the GETD shall, at its discretion, issue guidelines for JTPA programs and interpretations of JTPA and related regulations and issuances by DOL. These guidelines and interpretations shall be issued as "GETD policy" and shall provide guidance on implementation of JTPA activities to SDAs, contractors and agencies administering JTPA funds.~~

~~B. Periodically, DOL issues Training and Employment Information Notices and Training and Employment Guidance Letters to provide guidance on the implementation of JTPA. The GETD will, as appropriate, provide copies of these issuances to SDAs and state agencies administering JTPA funds. Guidance provided in these documents will be incorporated into GETD policy as appropriate.~~

## 16 VAC 10-20-80. Relocation.

~~The GETD will promptly review and take appropriate action, including consultation with and referral to DOL, with regard to alleged violations of the provisions of paragraphs (a) and (b) of s. 627-215 (Relocation) of the DOL regulations which prohibit the use of JTPA funds to encourage or induce the relocation of any part of an establishment.~~

~~A. In order to demonstrate compliance with requirements in § 141 (c) of JTPA that prohibit use of funds to support business relocation, SDAs and AAAs shall conduct a pre-award review prior to funding programs and activities for new or expanding business.~~

~~B. The review shall, at a minimum, address the following:~~

- ~~1. The names under which the establishment does business, including successors-in-interest;~~
- ~~2. The name, title, and address of the company official certifying the information;~~
- ~~3. The name and address of the facility in the other geographic location which is being closed or from which business is being transferred;~~

4. A statement from the employer about job losses at that location;
5. The nature of the products or business being transferred;
6. The date the facility will commence or expand operations; and
7. Whether JTPA assistance is sought in connection with past or impending job losses at other facilities.

C. A written record of the review shall be maintained to support any decision to fund any programs and activities that benefit new or expanding businesses.

D. If ~~the GETD determines it is determined~~ that a violation of the provisions in § 141 (c) has occurred, the GETD shall require the SDA or AAA that has violated the provisions to:

1. Repay to the GETD an amount equal to the amount expended in violation of the prohibition; and
2. Pay to the GETD an additional amount equal to the amount required to be repaid under subdivision 1 of this section, unless the SDA demonstrates that it neither knew nor reasonably could have known (after an inquiry undertaken with due diligence) that it provided funds in violation of the prohibition.

#### **16 VAC 10-20-90. Displacement. (Repealed.)**

~~The GETD will promptly review and take appropriate action, including consultation with and referral to DOL, with regard to alleged violations of the prohibitions against displacement of current workers or of terminated or laid-off workers.~~

#### **16 VAC 10-20-100. Nepotism. (Repealed.)**

A. The following words and terms, for the purpose of this section, shall have the following meanings:

~~"Employ" means to hire, or to provide with a job that pays wages or a salary.~~

~~"Immediate family" means a person's spouse and any other relative, by blood, marriage (including step-children and step-parents) or adoption, who resides in the person's household.~~

~~"Person in administrative capacity" means a person having overall administrative responsibility, and a person having election, hiring, placement or supervisory responsibilities. It also includes a member of a public or private governing board or council which has oversight responsibilities.~~

~~B. The GETD shall not employ a person in a position funded in whole or in part under JTPA if a member of that person's immediate family is engaged in an administrative capacity for the GETD.~~

~~C. An SDA shall not employ a person in a position funded in whole or in part under JTPA if a member of that person's immediate family is engaged in an administrative capacity for that SDA.~~

~~D. An SDA contractor shall not employ a person in a position funded in whole or in part under JTPA if a member of that person's immediate family is engaged in an administrative capacity for the contractor.~~

#### **16 VAC 10-20-110. Responsibilities for reporting incidents of fraud and abuse.**

A. Any known or suspected incidents of fraud, waste, malfeasance, misapplication of funds, gross mismanagement, or other criminal acts in programs and activities which are funded, in whole or in part, by JTPA shall be immediately and directly reported to the DOL Office of Inspector General and the Executive Director of the GETD.

B. Any act, information or complaint which raises questions concerning possible illegal expenditures, or other unlawful activities shall be immediately and directly reported to the DOL Office of Inspector General and the Executive Director of the GETD.

#### **16 VAC 10-20-140. Sanctions.**

A. If, as a result of financial and compliance audits or failure to meet performance standards, the GETD determines that there is a substantial violation of a specific provision of JTPA, the DOL regulations or the GETD regulations, and that corrective action has not been taken, the SDA or AAA shall be subject to sanctions.

B. Sanctions against SDAs may include:

1. Issuance of a notice of intent to revoke approval of all or part of the plan affected;
2. Imposition of a reorganization plan; or
3. Any other such changes as are determined necessary to secure compliance or attainment of performance standards.

C. Sanctions against AAAs may include:

1. Issuance of a notice of intent to revoke approval of all or part of the agency's contract; or
2. Any other such changes as are determined necessary to secure compliance or attainment of performance standards.

#### **16 VAC 10-20-150. Liability for JTPA funds.**

A. The GETD shall hold SDAs the administrative entity and the grant recipient of the service delivery area responsible for JTPA funds received through grants and contracts from the GETD, and may ultimately hold the units of local government which that constitute the service delivery area responsible for such funds.

B. The GETD shall hold AAAs responsible for JTPA funds received from the GETD and may ultimately hold the governing board of the planning and service area responsible for such funds.

#### **16 VAC 10-20-160. Financial management and accounting standards.**

---

# Final Regulations

---

A. Each SDA *and* AAA shall maintain written fiscal and accounting procedures that will present fairly and with full disclosure its financial position and the results of its financial operation. The procedures shall be in conformity with generally accepted accounting principles and shall enable the users of financial reports to determine compliance with ~~legal and contractual provisions of JTPA and applicable regulations.~~

B. ~~SDAs and their contractors shall develop a system of written fiscal controls and accounting procedures which ensure compliance with JTPA regulations, policies, and guidance. Such Accounting~~ procedures shall, at a minimum, include the following:

1. Effective internal controls to safeguard assets and assure their proper use;
2. Methods to produce information pertaining to subgrant and contract awards, obligations, unobligated balances, assets, expenditures, and income;
3. Methods to compare actual expenditures with budgeted amounts for each subgrant and contract;
4. Requirements to maintain source documentation which support accounting records;
5. Methods to ensure proper charging of costs and cost allocation; and
6. *If appropriate*, methods to demonstrate compliance with the matching requirements.

C. At a minimum, standards of internal control must assure the following:

1. Competent key personnel;
2. Qualified supervision with clear line of responsibility and accountability;
3. Properly recorded and executed transactions;
4. Clear documentation of and accountability for resources and financial transactions;
5. Proper segregation of duties; and
6. Limitation in access to resources.

## 16 VAC 10-20-170. Administrative requirements.

A. Annually, each SDA *and* AAA shall notify the GETD of the identity of the ~~officers or officials~~ *individuals* authorized to ~~bind that SDA to agreements with the GETD or sign binding agreements and to request funds pursuant to such an agreement from the GETD.~~ This notification shall be made in accordance with instructions issued by the GETD.

B. Each SDA *and* AAA shall identify an individual to be principal contact for the accounting and fiscal operations. The name, title, and telephone number of this individual shall be provided to the GETD fiscal unit.

C. SDAs *and* AAAs shall ensure that their contractors adhere to all applicable federal and state laws and regulations, and to state and SDA procedures for the

operation of JTPA programs. SDAs *and* AAAs shall ensure that each ~~contractor~~ *of their contractors* has timely access to materials bearing on the administration of and performance under the contract.

## 16 VAC 10-20-180. Bonding. (Repealed.)

~~A. Every officer, director, agent or employee of an SDA which receives JTPA funds in advance of expenditure, who is authorized to act on the SDAs behalf for the purpose of receiving or depositing funds into program accounts or issuing financial documents, checks or other instruments of payment for program costs shall be bonded to provide protection against loss. The minimum amount of coverage shall be the lower of:~~

- ~~1. \$100,000, or~~
- ~~2. The highest advance during the previous program year.~~

~~B. SDAs shall ensure that contractors which receive payment in advance of performance or expenditure obtain adequate bonding against loss.~~

## 16 VAC 10-20-190. Liability for damages, losses and claims and indemnification.

A. The GETD assumes no liability with respect to bodily injury, illness, or any other damage or losses, or with respect to any claims arising out of any activity under a JTPA contract or agreement whether concerning persons or property in the SDA's, AAA's, state agency's, contractor's, or any other subrecipient's organization or any third party.

*B. The SDAs and AAAs agree to indemnify, defend and hold harmless the Commonwealth of Virginia, its officers, agents and employees from any claims, damages and actions of any kind or nature, whether at law or in equity, arising from or caused by the use of materials, goods, or equipment of any kind or nature furnished by the SDAs and AAAs, or any services of any kind or nature furnished by the SDAs or AAAs, provided that such liability is not attributed to the sole negligence of the using agency or to the failure of the using agency to use the materials, goods or equipment in the manner already and permanently described by the SDAs and AAAs on the materials, goods or services delivered.*

## 16 VAC 10-20-200. Procurement standards.

A. SDAs ~~which~~ *and* AAAs ~~that~~ do not operate within the control of a unit of local government *or a consortium of local governments* shall establish and maintain a written procurement system and attendant procedures which are in compliance with the provisions of the Virginia Public Procurement Act (§ 11-35 et seq. of the Code of Virginia) ~~as specified in the GETD Procurement Manual and this chapter.~~

1. *For the purpose of this provision, the Private Industry Council shall be the governing body as the terms are used in the Virginia Public Procurement Act.*
2. *For the purpose of this provision, the service delivery area administrative entity, if separate from the Private*

*Industry Council, shall be the public body as the terms are used in the Virginia Public Procurement Act.*

~~B. SDAs which and AAAs that operate within the control of a unit of local government or a consortium of local governments shall adhere to local government procurement policies and procedures.~~

~~C. No JTPA funds shall be used to duplicate existing facilities and services, except in those cases where it is demonstrated that the JTPA funded alternatives would be more effective and more likely to achieve required performance goals.~~

~~D. The personnel of each SDA, to include PIC members, must avoid organizational conflict of interest, personal conflict of interest, and the appearance of conflict of interest when carrying out their responsibilities under the JTPA. SDAs shall develop and maintain a written code of standards governing the performance of persons engaged in the award and administration of JTPA contracts and subgrants. The code shall, at a minimum, encompass the requirements of s 627.420(c) of the DOL regulations. SDAs may set minimum rules where the financial interest is not substantial or the gift is an unsolicited item of nominal intrinsic value.~~

~~C. All procurement activity shall comply with written policy and procedures that ensure accountability and prevent waste, fraud and abuse.~~

~~E. D. SDAs and AAAs shall monitor all procurement activities on an annual basis and report this information to the GETD as part of their monitoring function. The GETD shall monitor the SDA and AAA procurement process to ensure compliance.~~

**16 VAC 10-20-210. Standards for selection of service providers. (Repealed.)**

~~A. SDAs, to the extent practicable, shall select service providers on a competitive basis, in accordance with the standards established in s 627.420(b) of the DOL regulations and 16 VAC 10-20-200 of this chapter. When an SDA determines that services will be provided by its own staff, a determination shall be made of the demonstrated performance of the staff to operate the program. This determination shall be in writing and evaluate the SDA on the items listed in subsection C of this section.~~

~~B. SDAs shall complete determinations of demonstrated performance in writing prior to the award of a grant, subgrant, contract or subcontract.~~

~~C. Awards are to be made to organizations possessing the demonstrated ability to perform successfully under the terms and conditions of a proposed subgrant or contract. Such determinations shall be in writing and shall, at a minimum, assess whether the organization has:~~

- ~~1. Adequate financial resources or the ability to obtain them;~~
- ~~2. The ability to meet the program design specifications at a reasonable cost, as well as the ability to meet performance goals;~~

~~3. A satisfactory record of past performance (in job training, basic skills training, or related activities), including demonstrated quality of training; reasonable drop-out rates from past programs; the ability to provide or arrange for appropriate supportive services as specified in the Individual Service Strategy, including child care; retention in employment; and earning rates of participants;~~

~~4. For Title II programs, the ability to provide services that can lead to the achievement of competency standards for participants with identified deficiencies;~~

~~5. A satisfactory record of integrity, business ethics, and fiscal accountability;~~

~~6. The necessary organization, experience, accounting and operational controls; and~~

~~7. The technical skills to perform the work.~~

~~D. In selecting service providers to deliver services in an SDA, proper consideration shall be given to community based organizations which are recognized in the community in which they are to provide services.~~

~~Appropriate education agencies in the SDA shall be provided the opportunity to provide educational services, unless the SDA demonstrates, in writing, that an alternative agency or organization would be more effective or would have greater potential to enhance the participants' continued educational and career growth.~~

~~In determining demonstrated performance of institutions and organizations which provide training, such performance measures as retention in training, training completion, job placement, certifiable training and rates of licensure shall be taken into consideration.~~

**16 VAC 10-20-220. Standards for OJT (On-the-Job-Training) contracts. (Repealed.)**

~~A. SDAs and their subcontractors shall not enter into or otherwise extend On the Job Training Contracts with employers when the following conditions exist:~~

~~1. The employer had two or more OJT contracts within the preceding 12 months, and exhibited a pattern of failing to provide OJT participants with continued long-term employment (at least six months) as regular employees with wages and working conditions at the same level and to the same extent as similarly situated employees;~~

~~2. The employer provided wages and benefits received by the OJT participant were not at the same level as other employees similarly employed; or~~

~~3. The employer terminated OJT participants without cause.~~

~~B. SDAs and their subcontractors are required to monitor OJT contracts to ensure that the employer meets the requirements specified above.~~

---

# Final Regulations

---

## 16 VAC 10-20-230. ~~Cost principles. (Repealed.)~~

~~To be allowable, a cost shall be necessary and reasonable for the proper and efficient administration of the program, be allocable to the program, and not be a general expense required to carry out the overall responsibilities of a governmental subrecipient. Costs charged to the program shall be accorded consistent treatment through application of generally accepted accounting principles. A cost is reasonable if, in its nature and amount, it does not exceed that which a prudent person would accept under the circumstances prevailing at the time the decision was made to incur the cost. In considering the reasonableness of a given cost, consideration should be given to:~~

- ~~1. Whether the cost is of a type generally recognized as ordinary and necessary for the operation of the JTPA program;~~
- ~~2. The restraints or requirements imposed by such factors as sound business practices, arms length bargaining, federal, state and other laws and regulations, and terms and conditions of the JTPA awards;~~
- ~~3. Market prices for comparable goods and services;~~
- ~~4. Whether the individuals concerned acted with prudence the circumstances considering their responsibilities to the organization, its employees, the public at large and the federal government; and~~
- ~~5. Significant deviations from the established practices of the subrecipient organization which may unjustifiably increase the federal award's cost.~~

## 16 VAC 10-20-240. Allowable cost.

A. The following ~~provides direction on~~ are allowable costs. Since this list is not all inclusive, GETD fiscal staff should be consulted if there is any question concerning the allowability of a specific cost item.

1. Accounting costs for establishing and maintaining accounting and other information systems required for the management of the JTPA program including the costs of identifiable services incurred by central service agencies when used for JTPA purposes;
2. Advertising costs to include newspapers, radio and television programs, direct mail, and trade papers. The advertising costs which are allowable are those which are solely for the recruitment of personnel required for the grant program, solicitation of bids for the procurement of goods and services required, disposal of surplus materials acquired in the performance of the grant agreement, and the outreach and recruitment of participants;
3. Audit services necessary for the administration and management of functions related to the JTPA program including costs of the required annual single audit;
4. Bonding costs for premiums on bonds covering employees who handle subrecipient JTPA funds;

5. Budgeting costs incurred for the development, preparation, presentation, and execution of budgets. Costs for services of a central budget office are generally not allowable since these are costs of general government. However, where employees of the central budget office actively participate in the subrecipient's JTPA budget process, the cost of the identifiable services is allowable;

6. Building space costs including rent and repairs in privately or publicly owned buildings used for the benefit of the JTPA program. The total cost of space, whether in a privately or publicly owned building, may not exceed the rental cost of comparable space and facilities in the same locality. Maintenance and operation costs including utilities, insurance, security, janitorial services, elevator services, upkeep of grounds, and normal repairs to the extent that they are not otherwise included in rental or other charges for space are allowable;

7. Communication costs incurred for telephone calls or service, teletype service, wide area telephone service, centrex, telpak, telefax, postage, messenger service, and similar expenses when used in support of JTPA activities;

8. Compensation in the form of depreciation and use allowances for the use of buildings, other capital improvements, and equipment on hand. Use allowances are the means of providing compensation in lieu of depreciation. The computation of use allowances or depreciation or both must comply with the guidelines contained in the appropriate OMB circular (OMB Circular A-87 for State and Local Governments 58 FR 44212, A-122 for Private Nonprofit Organizations (Office of Management and Budget, July 1980), and A-21 for Educational Institutions 51 FR 43487) regarding the allowability of such costs;

9. Fees or profits which are determined through procurement to be reasonable and not excessive;

10. Insurance costs for coverage of injuries suffered by participants who are not covered by existing workers' compensation, personal liability insurance for PIC members, and other required insurance coverage to the degree that the types and extent and cost of coverage is in accordance with general local policy and general business practice;

~~11. Interest expense, paid to an external party, associated with the acquisition of capital equipment if such assets are used to support the JTPA program and the total costs are less than \$1,000 per unit, including property acquired through lease/purchase agreements and lease agreements with aggregate payments under \$1,000;~~

~~12.~~ 11. Legal expenses required in the administration of the JTPA program, such as expenses incurred by the JTPA system in the establishment and maintenance of a grievance system, including hearings and appeals, and related expenses such as lawyers' fees. Expenses for

services furnished by the chief legal officer of a state or local government or staff solely for the purpose of discharging general responsibilities as a legal officer are not allowable. Legal expenses for the prosecution of claims against the federal government, including appeals to an Administrative Law Judge, are also unallowable;

~~13-~~ 12. Memberships, subscriptions, and professional activities, including staff training, which support and enhance the management and operation of JTPA activities;

~~14-~~ 13. Participant support services including needs-based payments determined in accordance with locally developed formula and, ~~for youth enrolled in Title II-C programs,~~ cash incentives and bonuses;

~~15-~~ 14. Payments to OJT employers, training institutions and other vendors incurred for training and employment services to eligible JTPA participants;

~~16-~~ 15. Personal services compensation, including wages, salaries, supplementary compensation and fringe benefits for staff engaged in activities supporting JTPA;

~~17-~~ 16. Preagreement costs incurred prior to the effective date of a subgrant or contract when specifically provided for in the subgrant or contract;

~~18-~~ 17. Printing and reproduction services necessary for grant administration including but not limited to forms, reports, manuals, and informational literature;

~~19-~~ 18. Costs incurred by private industry councils which are established pursuant to the JTPA regulations and other advisory councils established to facilitate the provision of job training and related services;

~~20-~~ 19. Professional services rendered by individuals or organizations not a part of the SDA or AAA, including organizational management studies conducted by outside individuals or firms;

~~21-~~ 20. Supplies, equipment and materials for use by participants while on the job and for the use in the training of participants;

~~22-~~ 21. Taxes or payments in lieu of taxes ~~which that~~ the JTPA subrecipient SDA or AAA is legally required to pay;

~~23-~~ 22. Travel costs for expenses for transportation, lodging, subsistence, and related items incurred by employees who are in travel status on official business incident to the JTPA program; and

~~24-~~ 23. Transportation costs incurred for freight, cartage, express, postage and other transportation costs relating to either goods purchased, delivered, or moved from one location to another.

B. The following costs are allowable with prior *written* approval from the GETD *Division of Administration and Finance*:

1. Alterations, building reconstruction and remodeling of facilities required specifically for the JTPA program;

2. Acquisition of capital assets;

3. Fund raising costs; and

4. Purchase or disposal of property having an ~~acquisition cost of \$1,000 a value of \$5,000~~ or more per unit, ~~including property acquired through lease/purchase agreements and lease agreements with aggregate payments exceeding \$1,000.~~

C. In addition to the costs specified in § 20 CFR 627.435(e) ~~of the DOL regulations,~~ the following costs are not allowable:

1. Interest incurred on borrowed working capital or on the use of an organization's own funds, and

2. International travel.

### **16 VAC 10-20-250. Cost categories. (Repealed.)**

~~A. Funds expended under Title II-A and Title II-C shall be charged to one of the following categories:~~

~~1. Administration;~~

~~2. Direct training services; and~~

~~3. Training related and supportive services.~~

~~B. Funds expended under Title II-B shall be charged to one of the following categories:~~

~~1. Administration; or~~

~~2. Training and participant support.~~

~~C. Funds expended under Title III shall be charged to one of the following categories:~~

~~1. Administration;~~

~~2. Rapid response services;~~

~~3. Retraining services;~~

~~4. Basic readjustment services; and~~

~~5. Needs related payments and supportive services.~~

### **16 VAC 10-20-260. Cost limitations. (Repealed.)**

~~A. Of the funds provided to an SDA under Title II-A and Title II-C:~~

~~1. Not more than 20% shall be expended for administration, with the exception of administrative costs incurred by a community-based organization or nonprofit organization. Administrative costs incurred by these organizations shall not be included in the 20% administration limitation if the conditions described in § 627.445(d) are met.~~

~~2. Not less than 50% of the allocation shall be expended for direct training services, except as provided for in subdivision 1 of this subsection.~~

---

# Final Regulations

---

~~B. Of the funds provided to an SDA under Title II-B, exclusive of any funds transferred to Title II-C in accordance with s 256, not more than 15% shall be expended for administration.~~

~~C. The limitations of costs Title II-A, Title II-B and Title II-C shall be applied separately to funds allocated under each program and shall be based on the net of any:~~

- ~~1. Transfers made in accordance with ss 206, 256 and 266 of the Act; and~~
- ~~2. Reallocations made by the GETD in accordance with s 109(a) of the Act.~~

~~D. Of the funds allocated to an SDA under Title III:~~

- ~~1. Not more than 15% of the allocation shall be expended on administrative costs;~~
- ~~2. Not more than 25% of the allocation shall be expended on needs-related payments and supportive services; and~~
- ~~3. Except as provided below, not less than 50% of the allocation shall be expended for retraining services.~~

~~a. SDAs may request a waiver from the requirement to expend 50% of the allocation for retraining. Waivers may be used to increase the level of expenditure for basic readjustment services and to decrease retraining expenditure.~~

~~b. In no case will a waiver increase the availability of funds for expenditure in the categories of administration and needs-related payments and supportive services. Additionally, a waiver may not reduce the minimum limitation on retraining services below 30%.~~

## **16 VAC 10-20-270. Financial reports. (Repealed.)**

~~SDAs shall submit the following financial reports to the GETD:~~

- ~~1. Cash forecast report submitted monthly;~~
- ~~2. Cash management report submitted monthly;~~
- ~~3. Quarterly expenditure report submitted on or before the last day of the month immediately following the end of quarter;~~
- ~~4. Preliminary closeout package submitted within thirty days following the close of the contract; and~~
- ~~5. Final closeout package submitted within 60 days following the close of the contract.~~

## **16 VAC 10-20-275. Property.**

*A. The purchase and disposal of property having an acquisition cost of \$5,000 or more per unit, including property acquired through lease/purchase agreements and lease agreements with aggregate payments exceeding \$5,000, must be approved in advance by the GETD.*

*B. Property purchased with JTPA funds that has an acquisition cost between \$300 to \$4,999 shall be the property of the SDA or AAA. If no longer needed in the JTPA programs, the property shall be used in other federally funded programs. If no need exists, the property may be disposed through competitive sale. All proceeds from the sale shall revert to JTPA.*

*C. Property purchased with JTPA funds with an acquisition cost of less than \$300 shall become the property of the purchasing agency. Disposal of this property shall be at the discretion of the SDA or AAA. Any proceeds from the disposition shall revert to JTPA.*

## **16 VAC 10-20-280. Maintenance and retention of records.**

A. Except as provided in this section, SDAs and AAAs shall retain JTPA records, including financial, statistical and participant information, and supporting documentation for a period of three years. The retention period shall begin on the date of submission of the final expenditure report for the particular grant or program.

1. If, prior to the expiration of the retention period, any litigation or audit is begun or a claim is instituted involving the grant covered by the records, the SDA shall retain the records beyond the three-year period until the litigation, audit finds or claim has been finally resolved.

2. All records for nonexpendable property shall be retained for three years after the final disposition.

B. In the event of the termination of an agreement or contract, SDAs and AAAs shall be responsible for ensuring that appropriate arrangements are made for the retention of records.

C. Upon written request by the GETD, SDAs and AAAs shall transfer JTPA records to GETD custody. The request will be made when the GETD determines that such records possess long-term retention value or are needed for audit or compliance purposes or both.

## **16 VAC 10-20-290. Access to records. (Repealed.)**

~~The GETD and any of its authorized representatives have the right of timely and reasonable access to any books, documents, papers, computer records, or other records of recipients and subrecipients that are pertinent to the grant, in order to conduct audits and examinations, and to make excerpts, transcripts, and photocopies of such documents. This right also includes timely and reasonable access to SDA and SDA contractor personnel for the purpose of interview and discussion related to such documents. The right of access is not limited to the required retention period but shall last as long as the records are retained.~~

## **16 VAC 10-20-300. Participant records.**

A. The GETD shall maintain an automated system for collection of data on applicants for and participants in JTPA programs and activities. SDAs not using the GETD system must utilize an automated system which is compatible with the system maintained by the GETD. The GETD retains the



right to approve automated participant record systems utilized by SDAs.

~~B. SDAs shall establish and adhere to procedures to ensure that data is entered to the automated system accurately and completely and in a timely manner.~~

~~C. The GETD will provide off-site storage for data collected. Each SDA shall submit, according to instructions from the GETD, data to the GETD.~~

**PART IV.  
AUDIT REQUIREMENTS.**

**16 VAC 10-20-310. Frequency of audits. (Repealed.)**

~~Annual audits will be conducted based on availability of administrative funds. Should funds not be available for annual audits, audits will be performed at least once every two years as directed by the GETD. The GETD reserves the right to audit or to require the audit of any or all of the SDAs as the need is determined.~~

**16 VAC 10-20-320. Audit method. (Repealed.)**

~~A. A single audit firm shall be selected to audit the SDAs. The firm shall be selected by the GETD in consultation with the SDAs. Each audit shall be conducted in accordance with the standards set forth in JTPA § 164(a). Audits conducted under Office of Management and Budget Circular A-128 or Circular A-133 may be accepted as a part of unified audits. Copies of A-128 and A-133 audit reports shall be submitted, upon availability, to the GETD.~~

~~B. SDAs are responsible for the cost of the audit related to the expenditure of funds by the SDA and must ensure that all of their contractors audit JTPA funds, unless A-128 and A-133 audits are performed.~~

~~C. Neither the GETD nor the SDAs shall audit state agencies receiving JTPA funds which are audited through the normal state audit process if the state audit includes financial and compliance testing that meet JTPA standards. If the state audit does not include JTPA funds, the state agency's JTPA programs shall be included in the unified audit.~~

~~D. State agencies which receive JTPA funds directly from the GETD shall be responsible for ensuring that the expenditure of those funds is audited. They shall be responsible for all audit fees, whether associated with state, unified, or individual audits and for audit resolution in accordance with the processes outlined below.~~

**16 VAC 10-20-330. Audit responsibilities. (Repealed.)**

~~A. SDAs and state agencies responsible for audits must immediately notify, in writing, the GETD of possible acts of fraud discovered during the performance of an audit.~~

~~B. The Virginia Auditor of Public Accounts shall determine the acceptability of the A-128 audit reports.~~

**16 VAC 10-20-340. Audit resolution. (Repealed.)**

~~A. The GETD fiscal section in conjunction with the GETD monitoring section is responsible for ensuring that SDAs and~~

~~other JTPA subgrantees are in compliance with the audit requirements. The GETD will utilize an audit tracking system to document and monitor the audit resolution process. The tracking system lists the date when the final audit report is received by the GETD, the number of administrative findings; the amount of questioned costs and the amount of cost recommended for disallowance; the date of the final determination; the amount of the final disallowed costs; and a section for comments or appeals information.~~

~~B. The GETD, within 30 days of the receipt of a final audit report, will review the report and forward an initial finding letter to the subgrantee. The initial letter lists all of the audit findings (Questioned Costs and Administrative Findings) identified in the report.~~

~~C. Within 30 days from receipt of the initial finding letter, the SDA shall prepare and submit a written response. The written response shall include any documentation needed to support questioned costs or costs recommended for disallowance; an explanation of any corrective actions taken or a plan for future corrective action; and any documentation to verify that corrective action has been taken or a timetable for the completion of the corrective action.~~

~~D. The GETD shall review the SDA's written response within 60 days following the receipt of the response. A determination regarding the adequacy of the action taken by the SDA to resolve the findings will be made. In order to make the determination, the GETD may request additional action on any finding considered not fully resolved. If the corrective action plan is determined adequate and acceptable a final determination will be issued.~~

~~E. The final determination will:~~

- ~~1. Indicate that the responses to the administrative findings are acceptable to the GETD;~~
- ~~2. List any costs which have been determined allowable or unallowable; and~~
- ~~3. Establish a debt for any disallowed costs and designate a date by which repayment, if any, must be made.~~

~~F. The GETD monitoring staff will follow up on audit resolution corrective actions, when deemed appropriate, during the next on-site monitoring visit. The monitors, if necessary may require additional actions to be taken to ensure compliance with the approved audit corrective action plan.~~

~~G. The determination by any agency to allow questioned costs does not preclude the Secretary of DOL from making a determination that the costs are unallowable and demanding a refund from nonfederal funds. Consequently, a determination of allowability of costs shall not be final until accepted by DOL.~~

**16 VAC 10-20-350. Disallowed costs. (Repealed.)**

~~Any costs disallowed shall be the sole responsibility of the SDA or state agency. In the event it is determined that disallowed costs require repayment, repayment shall be~~

---

# Final Regulations

---

made by the SDA or state agency, upon request by the GETD, out of nonfederal funds.

## **16 VAC 10-20-360. ~~Appeal of final determination. (Repealed.)~~**

~~A. SDAs shall afford subrecipients the opportunity to appeal the final determination of disallowed costs. SDAs and other grantees have the right to appeal the GETD's final determination of disallowed costs. To be considered, an appeal shall be filed not less than 15 days nor more than 30 days, after the issuance of the final determination. Appeals shall be filed pursuant to the GETD grievance procedures specified in Part VI of this chapter.~~

## **16 VAC 10-20-370. ~~Federal equal opportunity laws and regulations. (Repealed.)~~**

~~Programs and activities funded or otherwise financially assisted in whole or in part under the Job Training Partnership Act (JTPA) are subject to federal equal opportunity (EO) laws and regulations. Recipients of federal funds under JTPA must comply with the EO requirements that have evolved from the following:~~

- ~~1. Civil rights laws prohibiting discrimination on the grounds of:
  - a. Race, color, and national origin (Title VI, Civil Rights Act of 1964, 42 USCS §§ 1971, 1975a-1975d, 2000a-2000h-6, as amended);
  - b. Age (Age Discrimination Act of 1975, 42 USCS §§ 6101 et seq., as amended);
  - c. Disability (Rehabilitation Act of 1973, 29 USCS §§ 701 et seq., as amended);
  - d. Sex (Title IX Education Amendments of 1972, (see 86 stat. 235) as amended);~~
- ~~2. JTPA's § 167 which describes the Act's civil rights coverage on the grounds of religion, political affiliation or belief, and for beneficiaries, citizenship and participation in JTPA;~~
- ~~3. Implementing regulations, specifically:
  - a. 29 CFR Part 31, Title VI of the Civil Rights Act;
  - b. 29 CFR Part 32, § 504 of the Rehabilitation Act;
  - c. 41 CFR Part 60-3, Uniform Guidelines on Employee Selection Procedures; and
  - d. 29 CFR Part 34, JTPA;~~
- ~~4. State's Methods of Administration (MOA); and~~
- ~~5. DOL Directorate of Civil Rights and state policy directives.~~

## **16 VAC 10-20-380. ~~Other federal laws. (Repealed.)~~**

~~Other federal laws that impact the operations of state and local level JTPA programs include, but are not limited to, the following:~~

- ~~1. Immigration Reform and Control Act of 1986 (8 USCS § 1101 nt.);~~
- ~~2. Title VII, Civil Rights Act of 1964 (42 USCS §§ 1971, 1975a-1975d, 2000a-2000h-6, as amended);~~
- ~~3. Equal Pay Act (29 USCS § 206 et seq.);~~
- ~~4. Age Discrimination in Employment Act (29 USCS §§ 621-634); and~~
- ~~5. Americans with Disabilities Act of 1990 (42 USCS 12101 nt.).~~

## **16 VAC 10-20-390. ~~Equal opportunity program. (Repealed.)~~**

~~Consistent with the legal and regulatory requirements of JTPA and Virginia's JTPA Methods of Administration (MOA), each SDA and any other recipient shall establish and maintain a comprehensive equal opportunity program throughout their respective JTPA-funded programs and activities to include written policies and procedures governing all aspects of employment and employment practices.~~

## **16 VAC 10-20-400. ~~Compliance. (Repealed.)~~**

~~SDA's and any other recipients shall ensure compliance with GETD's equal opportunity and related policies, procedures, and administrative directives and the state's Methods of Administration to include, but not limited to, the following:~~

- ~~1. Designation of an equal opportunity officer;~~
- ~~2. Development of a system of EO policy communication and staff training to ensure that all staff are aware of and can implement their related responsibilities;~~
- ~~3. Compliance assurance with the nondiscrimination and equal opportunity laws and regulations included in plans, contracts, and other similar agreements to carry out JTPA-funded programs;~~
- ~~4. Establishment of a plan or plans describing efforts to provide equitable services to substantial segments of the population eligible for participation in JTPA;~~
- ~~5. Administration of JTPA-funded programs and activities to ensure physical as well as programmatic accessibility to individuals with disabilities, that programs are provided in the most integrated environment appropriate to the qualified individual with disability, and that communications with individuals with disabilities are as effective as communications with others;~~
- ~~6. Collection and maintenance of EO data and provision of reports on applicants, eligible applicants, participants, trainees, employees and applicants for employment. Such information shall be maintained in a manner as to ensure confidentiality and shall be used only for recordkeeping and reporting, determining applicant eligibility, determining program compliance with~~

nondiscrimination requirements, or other use as authorized by JTPA's nondiscrimination and equal opportunity provision;

7. Development of a system for monitoring local program operations to ensure compliance with the nondiscrimination and equal opportunity provisions of the Act;

8. Compliance with and publication of the JTPA Discrimination Complaint Procedures established by GETD and maintenance of a log of discrimination complaints. Recipients shall promptly notify GETD of any complaints, administrative enforcement actions or lawsuits filed against it alleging discrimination; and

9. Establishment of procedures for obtaining prompt corrective action or, as required, application of sanctions when a service provider is not in compliance with the nondiscrimination and equal opportunity provisions of the Act, related regulatory requirements, and state and local policies, procedures, and administrative directives.

**16 VAC 10-20-410. EO (Equal Opportunity) officers- (Repealed.)**

A. EO officers shall report directly to the highest level JTPA official on matters related to EO and shall be provided the opportunity to attend at least one EO related workshop, seminar, or conference per program year.

B. EO officers shall coordinate local level JTPA/EO responsibilities to include ensuring service provider compliance with the nondiscrimination and equal opportunity provisions of JTPA.

C. Service providers shall not be required to designate an EO officer. SDAs may require that a service provider designate an individual responsible for publicizing discrimination complaint procedures, ensuring that the established procedures are followed, and serving as liaison with the SDA.

**16 VAC 10-20-420. Program complaints- (Repealed.)**

A. Pursuant to PL 99-570, § 144; § 2.1-708(3) of the Code of Virginia; and DOL regulations §§ 627.500 through 627.504, the GETD shall maintain the JTPA Program Complaint Procedure (Governor's Employment and Training Department, eff. 8/1/94) for addressing any grievance or complaint alleging a violation of the JTPA rules, regulations, grants, or other agreements made under the Act by the Commonwealth of Virginia, its service delivery areas, other recipients, or service providers. The procedure shall also be available for the resolution of issues arising from audit disallowances and findings, investigations, monitoring reports, or the imposition of any sanction made, conducted, or imposed by the GETD.

B. Each JTPA recipient shall comply with the JTPA Program Complaint Procedures established by the GETD for resolving complaints and grievances arising in connection with JTPA programs operated by the SDA or any other recipient.

C. Any employer, including private-for-profit, who is a recipient of JTPA funds, shall continue to operate or shall establish and maintain for JTPA participants, a grievance or complaint procedure relating to the terms and conditions of employment available to participants. The employer's procedure shall incorporate a process of review by the SDA or any other recipient of the final decision and opportunity for the grievant to appeal to GETD. An employer may utilize their complaint system or the Commonwealth of Virginia, JTPA Program Complaint Procedures. SDAs shall inform participants which grievance procedure to follow when the participant begins employment and shall maintain documentation indicating signed notification with the participant's file.

D. Grievances and complaints which do not fall within the purview of subsection A of this section are not subject to this procedure and include:

1. Allegations of irregularities in the procurement of goods and services;
2. Allegations of a violation of the nondiscrimination and equal opportunity provisions of JTPA on the ground of race, color, religion, sex, national origin, age, disability, political affiliation or belief, and for beneficiaries, citizenship or participation in programs funded under the JTPA; and
3. Issues related to the terms and conditions of employment for GETD employees, and for participants, except when an employer of participants, including a private-for-profit employer, does not have a grievance or complaint procedure established.

E. Where the alleged violation of the Act or regulations is also an alleged violation of another law, regulation, or agreement, nothing in the JTPA Program Complaint Procedures shall preclude an individual or organization from instituting a civil action or pursuing other remedies under such other law or agreement with respect to the non-JTPA cause of action, at the same time that a complaint under this procedure is pending.

F. With the exception of complaints alleging violations of the labor standards under § 143 of JTPA, a decision rendered by GETD, in accordance with the Commonwealth of Virginia, JTPA Program Complaint Procedures, shall be final unless the Secretary of Labor exercises authority for federal level review consistent with the provisions at 20 CFR, Part 627, Subpart F, "Federal handling of non-criminal complaints and other allegations."

**16 VAC 10-20-430. Discrimination complaints- (Repealed.)**

A. Pursuant to PL 99-570, § 167, and to the United States Department of Labor for programs under the JTPA in accordance with 29 CFR Part 34, the GETD, Commonwealth of Virginia, shall maintain the JTPA Discrimination Complaint Procedure for addressing any complaint alleging discrimination on the basis of race, color, national origin, religion, sex, age, disability, political affiliation or belief and, for beneficiaries only, citizenship or participation in JTPA.

---

# Final Regulations

---

~~B. Each JTPA recipient shall comply with the JTPA Discrimination Complaint Procedure established by the GETD for resolving complaints of unfair treatment due to a prohibited factor in connection with JTPA programs operated by the SDA or any other recipient.~~

~~C. Each JTPA recipient shall provide for local level processing of complaints consistent with the JTPA Discrimination Complaint Procedures by the GETD.~~

~~D. JTPA recipients shall ensure initial and continuing notification of the right to file a complaint and an individual's option for local level processing of a complaint.~~

~~1. SDAs, other recipients and service providers shall post "Equal Opportunity Is the Law" notices in prominent locations that are available to applicants, eligible applicants, participants, applicants for employment, employees, unions or professional organizations holding collective bargaining or professional agreements with the recipient, and members of the public.~~

~~2. Recipients and service providers shall also ensure that the notice is disseminated in internal memoranda and other written communication, included in handbooks or manuals, provided to other recipients when financial assistance is passed, is made available in formats suitable for those with visual or hearing impairments and in languages other than English where a significant portion of the eligible population needs information in a language other than English.~~

~~3. Participants and employees shall be provided forms containing the notice with receipt of notice confirmed by participant/employee signature. The notice shall also be made part of the participant's/employee's file.~~

## **16 VAC 10-20-440. Notice. (Repealed.)**

~~SDAs, other recipients, and service providers shall post notice of the available administrative procedures to include JTPA program and discrimination complaint procedures and inform participants of the appropriate procedure and the contact person in the event of a complaint. The terms of the JTPA procedure shall not be amended by recipients or service providers.~~

## **16 VAC 10-20-450. Recordkeeping. (Repealed.)**

~~A. GETD shall maintain a log of all program and discrimination complaints filed at the local, state, and federal levels.~~

~~B. SDAs and other recipients shall maintain a log of complaints filed that allege discrimination on the ground of race, color, national origin, religion, sex, age, disability, political affiliation or belief and, for beneficiaries only, citizenship or participation in JTPA. The log shall include the name and address of the complainant, the ground of the complaint, a description of the complaint, the date filed, the disposition and date of disposition of the complaint, the agency/entity with which the complaint was filed, and any other pertinent information.~~

## **16 VAC 10-20-460. Notification of complaint. (Repealed.)**

~~SDAs and other recipients shall ensure that information pertaining to discrimination complaints, including complaint logs, are maintained in such a manner as to ensure confidentiality of the information and used only for the purposes of recordkeeping and reporting; determining the extent to which the entity is operating its JTPA-funded programs or activities in a nondiscriminatory manner; or other use authorized by the nondiscrimination and equal opportunity provisions of JTPA.~~

~~SDAs and other recipients shall notify the GETD's Human Resources Office upon the initial filing of a program or discrimination complaint or both.~~

VA.R. Doc. No. R98-249; Filed June 3, 1998, 10:16 a.m.

---

## **TITLE 18. PROFESSIONAL AND OCCUPATIONAL LICENSING**

### **REAL ESTATE BOARD**

Title of Regulation: **18 VAC 135-20-10 et seq. Virginia Real Estate Board Licensing Regulations (amending 18 VAC 135-20-10, 18 VAC 135-20-20, 18 VAC 135-20-30, 18 VAC 135-20-40, 18 VAC 135-20-50, 18 VAC 135-20-60, 18 VAC 135-20-80, 18 VAC 135-20-90, 18 VAC 135-20-100, [ 18 VAC 135-20-110, ] 18 VAC 135-20-120, [ 18 VAC 135-20-150, ] 18 VAC 135-20-160, 18 VAC 135-20-170, 18 VAC 135-20-180, [ 18 VAC 135-20-190, 18 VAC 135-20-200, ] 18 VAC 135-20-210, 18 VAC 135-20-220, 18 VAC 135-20-240, [ 18 VAC 135-20-250, ] 18 VAC 135-20-260, 18 VAC 135-20-270, 18 VAC 135-20-280, 18 VAC 135-20-290, 18 VAC 135-20-300, 18 VAC 135-20-310, [ 18 VAC 135-20-320, ] 18 VAC 135-20-350, 18 VAC 135-20-360, 18 VAC 135-20-370, 18 VAC 135-20-380, 18 VAC 135-20-390, [ 18 VAC 135-20-400 ] and 18 VAC 135-20-410; adding 18 VAC 135-20-45; repealing 18 VAC 135-20-420, 18 VAC 135-20-430, and 18 VAC 135-20-440).**

Statutory Authority: § 54.1-2105 of the Code of Virginia.

Effective Date: September 1, 1998.

#### Summary:

*The amendments to the regulations governing real estate agents (i) add language consistent with §§ 54.1-2130 through 54.1-2144 of the Code of Virginia which became effective October 1, 1995; (ii) clarify requirements for firm licenses; (iii) require reciprocal applicants for licensure to pass the Virginia law and regulation portion of the licensing examination; (iv) delete the requirement that applicants for a broker's license by reciprocity meet broker educational requirements equivalent to those required in Virginia; (v) amend the qualification for renewal and continuing education*

requirements; (vi) amend the maintenance and management of escrow accounts and financial records; (vii) clarify advertising practices by licensees; and (viii) add application and renewal fees for certified instructors.

**Summary of Public Comments and Agency's Response:** A summary of comments made by the public and the agency's response may be obtained from the promulgating agency or viewed at the office of the Registrar of Regulations.

**Agency Contact:** Copies of the regulation may be obtained from Karen W. O'Neal, Assistant Director, Real Estate Board, 3600 West Broad Street, Richmond, VA 23230, telephone (804) 367-8537.

## 18 VAC 135-20-10. Definitions.

The following words and terms, when used in this chapter, unless a different meaning is provided or is plainly required by the context, shall have the following meanings:

"*Actively engaged*" means *active licensed* employment by or affiliation as an independent contractor with a licensed real estate firm or sole proprietorship in performing those activities as defined in §§ 54.1-2100 and 54.1-2101 of the Code of Virginia for an average of at least ~~20~~ 40 hours per week.

"*Associate broker*" means any individual licensee of the board holding a broker's license other than one who has been designated as the principal broker.

"*Client*" means a person who has entered into a brokerage relationship with a licensee as defined by § 54.1-2130 of the Code of Virginia.

"*Firm*" means any *sole proprietorship (nonbroker owner), partnership, association, limited liability company, or corporation, other than a sole proprietorship (principal broker owner), which is required by 18 VAC 135-20-20 B of this chapter [ C B ] to obtain a separate brokerage firm license.*

"*Inactive status*" refers to any broker or salesperson who is not under the supervision of a principal broker or supervising broker, who is not affiliated with a firm or sole proprietorship and who is not performing any of the activities defined in §§ 54.1-2100 and 54.1-2101 of the Code of Virginia.

"*Independent contractor*" means a licensee who acts for or represents a client other than as a standard agent and whose duties and obligations are governed by a written contract between the licensee and the client.

"*Licensee*" means any person, partnership, association, *limited liability company, or corporation holding a license issued by the Real Estate Board to act as a real estate broker or real estate salesperson, as defined, respectively, in §§ 54.1-2100 and 54.1-2101 of the Code of Virginia.*

~~"*Principal*" means a party who has engaged a real estate broker to perform real estate purchases, sales or rental services in a principal-agent relationship.~~

"*Principal broker*" means the individual broker who shall be designated by each firm to assure compliance with Title

~~54.1, Chapter 21 (§ 54.1-2100 et seq.) of Title 54.1 of the Code of Virginia, and this chapter, and to receive communications and notices from the board which may affect the firm or any licensee employed by or affiliated with the firm. In the case of a sole proprietorship, the licensed broker who is the sole proprietor shall have the responsibilities of the principal broker. The principal broker shall have responsibility for the activities of the firm and all its licensees.~~

"*Principal to a transaction*" means a party to a real estate transaction in the capacity of a seller, buyer, lessee or lessor.

"*Sole proprietor*" means any individual, not a corporation, who is trading under the individual's name, or under an assumed or fictitious name pursuant to the provisions of ~~§ Chapter 5 (§ 59.1-69 through 59.1-76 et seq.) of Title 59.1 of the Code of Virginia.~~

"*Standard agent*" means a licensee who acts for or represents a client in an agency relationship. A standard agent shall have the obligations as provided in Article 3 (§ 54.1-2130 et seq.) of [ Chapter 21 of ] Title 54.1 of the Code of Virginia.

"*Supervising broker*" means the individual associate broker who shall be designated by the firm to supervise the activities of any one of its offices.

**18 VAC 135-20-20. Necessity for license [ or registration** (Refer to ] ~~§ 54.1-2106 [ § 54.1-2106.1 of the Code of Virginia).~~

~~[ A. No partnership, association or corporation shall be granted a firm license unless every member and officer of such partnership, association or corporation who actively participates in its brokerage business holds a license as a real estate broker, and unless every employee and every independent contractor who acts as salesperson for such partnership, association or corporation holds a license as a real estate salesperson; provided, however, that a person who holds a license as a real estate broker may act as a salesperson for another real estate broker.]~~

[ A. ] Sole proprietor (principal broker owner). A real estate broker's license shall not be issued to an individual trading under an assumed or fictitious name, that is, a name other than the individual's full name, until the individual signs and acknowledges a certificate provided by the board, setting forth the name under which the business is to be organized and conducted, the address of the individual's residence, and the address of the individual's place of business. Each certificate must be attested by the Clerk of Court of the county or jurisdiction wherein the business is to be conducted. The attention of all applicants and licensees is directed to §§ 59.1-69 through 59.1-76 of the Code of Virginia.

[ B. ] Sole proprietor (nonbroker owner), partnership, association, *limited liability company, or corporation. Every sole proprietor (nonbroker owner), partnership, association, limited liability company, or corporation must secure a real*

---

# Final Regulations

---

estate license for its brokerage firm before transacting real estate business. Application for such license shall disclose, and the license shall be issued to, the name under which the applicant intends to do or does business and holds itself out to the public. This license is separate and distinct from the individual broker license required of each partner, associate, *manager of a limited liability company*, and officer of a corporation who is active in the brokerage business.

1. Sole proprietor (nonbroker owner). Each sole proprietor (nonbroker owner) acting as a real estate broker shall file with the board a certificate on a form provided by the board, which shall include the following information: the name, business address, and residential address of the owner; the name and style of the firm; and the address of the office of the real estate entity. Each change in the information contained on the certificate filed with the board must be evidenced by filing a new certificate with the board within 30 days after the change is effective.

2. Partnership. Each partnership acting as a real estate broker shall file with the board a certificate on a form provided by the board, which shall include the following information: the name, business address, and residential address of each person composing the partnership; the name and style of the firm; the address of the Virginia office of the firm; and the length of time for which it is to continue. Every change in the partnership must be evidenced by filing a new certificate with the board within 30 days after the change is effective.

3. Association. Each association acting as a real estate broker shall file with the board a certificate on a form provided by the board, which shall include the following information: the name, business address, and residential address of each person composing the association; the name and style of the firm; the address of the Virginia office of the firm; and the length of time for which it is to continue. Every change in the association must be evidenced by filing a new certificate with the board within 30 days after the change is effective.

4. Corporation. Each corporation acting as a real estate broker shall file with the board a certificate on a form provided by the board, which shall include the following information: the name, business address, and residential address of each officer of the corporation; [ *the name of each licensed shareholder*; ] the name and style of the corporation; the address of the Virginia office of the firm; and the corporation's place of business.

a. Every change of officers must be evidenced by filing a new certificate with the board within 30 days after the change is effective.

b. The board will not consider the application of any corporation or its officers, employees, or associates until the corporation is authorized to do business in Virginia.

5. *Limited liability company*. Each limited liability company acting as a real estate broker shall file with the board a certificate on a form provided by the board, which shall include the following information: the name, business address, and residential address of each [ *licensed* ] manager [ or member ] of the company; the name and style of the company; and the address of the Virginia office of the company.

a. Every change of officers must be evidenced by filing a new certificate with the board within 30 days after the change is effective.

b. The board will not consider the application of any limited liability company or its officers, employees, or associates until the limited liability company is authorized to do business in Virginia.

[ C. ] Branch office license. If a real estate broker maintains more than one place of business within the state, a branch office license shall be issued for each branch office maintained. Application for the license shall be made on forms provided by the board and shall reveal the name of the firm, the location of the branch office, and the name of the supervising broker for that branch office. ~~Only~~ The branch office license shall be maintained at the branch office location.

## 18 VAC 135-20-30. Qualifications for licensure.

Every applicant to the Real Estate Board for a *an individual* salesperson's or broker's license shall have the following qualifications:

1. The applicant shall have a good reputation for honesty, truthfulness, and fair dealing, and be competent to transact the business of a real estate broker or a real estate salesperson in such a manner as to safeguard the interests of the public.

2. The applicant shall meet the current educational requirements by achieving a passing grade in all required courses of § 54.1-2105 of the Code of Virginia prior to the time the applicant sits for the licensing examination and applies for licensure.

3. The applicant shall be in good standing as a licensed real estate broker or salesperson in every jurisdiction where licensed and the applicant shall not have had a license as a real estate broker or real estate salesperson which was suspended, revoked or surrendered in connection with a disciplinary action or which has been the subject of discipline in any jurisdiction prior to applying for licensure in Virginia.

4. The applicant shall not have been convicted or found guilty regardless of adjudication in any jurisdiction of the United States of a misdemeanor involving moral turpitude, sexual offense, drug distribution or physical injury, or any felony, there being no appeal pending therefrom or the time for appeal having elapsed. Neither shall the applicant have been found to have violated the fair housing laws of any jurisdiction. Any plea of *nolo contendere* shall be considered a conviction for

purposes of this ~~paragraph~~ *subdivision*. The record of a conviction authenticated in such form as to be admissible in evidence under the laws of the jurisdiction where convicted shall be admissible as prima facie evidence of such conviction or guilt.

5. The applicant shall be at least 18 years old.
6. The applicant, within 12 months prior to making application for a license, shall have passed a written examination provided by the board or by a testing service acting on behalf of the board. Complete applications must be received within the 12-month period.
7. The applicant shall follow all rules established by the board with regard to conduct at the examination. Such rules shall include any written instructions communicated prior to the examination date and any instructions communicated at the site, either written or oral, on the date of the examination. Failure to comply with all rules established by the board with regard to conduct at the examination shall be grounds for denial of application.
8. *Applicants for licensure who do not meet the requirements set forth in subdivisions 3 and 4 of this section may be approved for licensure following consideration by the board [ in accordance with § 54.1-204 of the Code of Virginia ].*

#### **18 VAC 135-20-40. Additional qualifications for brokers.**

An applicant for a *an individual* license as a real estate broker shall meet the following requirements in addition to those set forth in 18 VAC 135-20-30 ~~of this chapter~~:

1. The applicant shall meet the current educational requirements of § 54.1-2105 of the Code of Virginia.
2. The applicant shall have been actively engaged as defined in 18 VAC 135-20-10 ~~of this chapter~~ as a real estate salesperson for a period of 36 of the 48 months immediately preceding application.

#### **18 VAC 135-20-45. Additional qualifications for salesperson's or associate broker's license as a business entity.**

*An applicant for a salesperson's license as a business entity shall meet the following requirements in addition to those set forth in 18 VAC 135-20-30:*

1. *Every owner or officer who actively participates in the real estate business shall hold a license as a salesperson or associate broker.*
2. *The name of the business entity shall include the full legal name of every owner or officer.*
3. *Partnership. Each partnership shall file with the board a certificate on a form provided by the board, which shall include the following information: the name, business address, and residential address of each person composing the partnership; the name and style of the firm; the address of the Virginia office of the firm;*

*and the length of time for which it is to continue. Every change in the partnership must be evidenced by filing a new certificate with the board within 30 days after the change is effective.*

4. *Association. Each association shall file with the board a certificate on a form provided by the board, which shall include the following information: the name, business address, and residential address of each person composing the association; the name and style of the firm; the address of the Virginia office of the firm; and the length of time for which it is to continue. Every change in the association must be evidenced by filing a new certificate with the board within 30 days after the change is effective.*

5. *Corporation. Each corporation shall file with the board a certificate on a form provided by the board, which shall include the following information: the name, business address, and residential address of each officer of the corporation; [ the name of each licensed shareholder; ] the name and style of the corporation; the address of the Virginia office of the firm; and the corporation's place of business.*

a. *Every change of officers must be evidenced by filing a new certificate with the board within 30 days after the change is effective.*

b. *The board will not consider the application of any corporation or its officers, employees, or associates until the corporation is authorized to do business in Virginia.*

6. *Limited liability company. Each limited liability company shall file with the board a certificate on a form provided by the board, which shall include the following information: the name, business address, and residential address of each [ licensed ] manager [ or member ] of the company; the name and style of the company; and the address of the Virginia office of the company.*

a. *Every change of officers must be evidenced by filing a new certificate with the board within 30 days after the change is effective.*

b. *The board will not consider the application of any limited liability company or its officers, employees, or associates until the limited liability company is authorized to do business in Virginia.*

#### **18 VAC 135-20-50. Concurrent licenses.**

Concurrent licenses shall be issued by the board to brokers active in more than one separate legal entity upon receipt of a concurrent license form and written affidavits stating that written notice of the applicant's concurrent licensure status has been provided to the principal broker of each firm with which the applicant is and will be associated. Payment is required for each license. *A concurrent license will not be issued to an individual applying to be associated*

---

# Final Regulations

---

with a firm if that individual has an expired license associated with the same firm and the expired license may be reinstated.

## 18 VAC 135-20-60. Qualifications for licensure by reciprocity.

A. Every applicant to the Real Estate Board for a license by reciprocity shall have the following qualifications provided in subsection B of this section, except that ~~18 VAC 135-20-50 A-5~~ subdivision B 6 of this section shall only be applicable for salesperson applicants.

~~A. B.~~ An individual who is currently licensed as a real estate salesperson or broker in another jurisdiction may obtain a Virginia real estate license [ ~~without taking the Virginia written licensing examination~~ ] by meeting the following requirements:

1. The applicant shall be at least 18 years of age.
2. The applicant shall have received the salesperson or broker's license by virtue of having passed in the jurisdiction of licensure a written examination deemed to be substantially equivalent to the Virginia examination.
3. The applicant, *within 12 months prior to making application for a license*, shall sign, ~~as part of the application, an affidavit certifying that the applicant has read and understands the~~ *have passed a written examination provided by the board or a testing service acting on behalf of the board covering Virginia real estate license law and the regulations of the Real Estate Board. Complete applications must be received within the 12-month period.*
4. *The applicant shall follow all rules established by the board with regard to conduct at the examination. Such rules shall include any written instructions communicated prior to the examination date and any instructions communicated at the site, either written or oral, on the date of the examination. Failure to comply with all rules established by the board with regard to conduct at the examination shall be grounds for denial of application.*

~~4. 5.~~ The applicant shall be in good standing as a licensed real estate broker or salesperson in every jurisdiction where licensed and the applicant shall not have had a license as a real estate broker or real estate salesperson which was suspended, revoked, or surrendered in connection with a disciplinary action or which has been the subject of discipline in any jurisdiction prior to applying for licensure in Virginia.

~~5. 6.~~ At the time of application for a salesperson's license, the applicant must have been actively engaged in real estate for 12 of the preceding 36 months or have met educational requirements that are substantially equivalent to those required in Virginia.

~~6. 7.~~ The applicant shall have a good reputation for honesty, truthfulness, and fair dealing, and be competent to transact the business of a real estate salesperson or broker in such a manner as to safeguard the interests of the public.

~~7. 8.~~ The applicant shall not have been convicted or found guilty regardless of adjudication in any jurisdiction of a misdemeanor involving moral turpitude, sexual offense, drug distribution or physical injury, or any felony there being no appeal pending therefrom or the time for appeal having elapsed. Neither shall the applicant have been found to have violated the fair housing laws of any jurisdiction. Any plea of nolo contendere shall be considered a conviction for purposes of this ~~paragraph~~ *subdivision*. The record of a conviction authenticated in such form as to be admissible in evidence under the laws of the jurisdiction where convicted shall be admissible as prima facie evidence of such conviction or guilt.

9. *Applicants for licensure who do not meet the requirements set forth in subdivisions 5 and 8 of this subsection may be approved for licensure following consideration by the board [ in accordance with § 54.1-204 of the Code of Virginia ].*

~~B. C.~~ Additional qualifications for reciprocal licensure as a broker. An individual who is currently licensed as a real estate broker in another jurisdiction may obtain a Virginia real estate broker's license ~~without taking a written examination~~ by meeting the following requirements *requirement set out in subsection D of this section* in addition to those set forth in ~~18 VAC 135-20-60 A 1 through A 4, A 6 and A-7~~ *subdivisions B 1 through B 5 and B 7 through B 9 of this section.*

~~4. D.~~ The applicant shall have been licensed as a real estate broker and actively engaged as a real estate broker or salesperson for at least 36 of the 48 months immediately prior to making application in Virginia. (See 18 VAC 135-20-10 of this chapter for the definition of "actively engaged.")

~~2. The applicant meets broker educational requirements substantially equivalent to those required in Virginia.~~

## 18 VAC 135-20-80. Application fees.

A. All application fees for licenses are nonrefundable and the date of receipt by the board or its agent is the date which will be used to determine whether it is on time.

B. Application fees for original licenses are as follows:

Salesperson by education and examination	\$ 90
Salesperson by reciprocity	\$ 75
Individual license - business entity	[ <del>\$ 100</del> \$ 90 ]
Broker by education and examination	\$ 100
Broker by reciprocity	\$ 100
Broker concurrent license	\$ 90
Firm license	\$ 145
Branch office license	\$ 75
Transfer application	\$ 35
Activate application	\$ 35
Bad check penalty	\$ 25

~~C. Examination fees are as follows:~~

Registration for sales and brokers	\$68.50
Additional fee for phone or "fax" registrations	\$ 5



C. The fee for examination or reexamination is subject to contracted charges to the board by an outside vendor. These contracts are competitively negotiated and bargained for in compliance with the Virginia Public Procurement Act (§ 11-35 et seq. of the Code of Virginia). Fees may be adjusted and charged to the candidate in accordance with these contracts. The fee shall not exceed \$90 per candidate.

**18 VAC 135-20-90. Renewal required.**

Licenses issued under this chapter for salespersons, brokers, and firms shall expire two years from the last day of the month in which they were issued, as indicated on the license, *except concurrent broker licenses which shall expire on the same date as the original broker license.*

**18 VAC 135-20-100. Qualification for renewal; continuing education requirements.**

A. ~~Continuing education requirements.~~ As a condition of renewal, and pursuant to § 54.1-2105 of the Code of Virginia, all active brokers and salespersons, resident or nonresident, except those called to active duty in the Armed Forces of the United States, shall be required to satisfactorily complete a course or courses of not less than a total of eight classroom, correspondence, or other distance learning instruction hours during each licensing term. Active licensees called to active duty in the Armed Forces of the United States may complete [ ~~this course~~ these courses ] within six months of their release from active duty. Inactive brokers and salespersons are not required to complete the continuing education course as a condition of renewal (see 18 VAC 135-20-70, Activation of license).

1. ~~Schools and instructors~~ Providers shall be those as required under § 54.1-2105 of the Code of Virginia, and ~~18 VAC 135-20-380 of this chapter defined in 18 VAC 135-20-350.~~

2. ~~The specific course content and curriculum shall be prescribed and approved by the board. The course curriculum shall be provided to each school in final form prior to the course offering and updated periodically to reflect recent developments in federal, state, and local real estate law, regulations and case decisions.~~

a. ~~Continuing education courses offered in other jurisdictions must meet Virginia's statutory requirements and must conform to the board's specifically prescribed course content and curriculum as described in § 54.1-2105(2) of the Code of Virginia. Such courses must be approved in advance of offering to be certified for course credit for licensees.~~

b. ~~Correspondence courses will not be approved for credit for continuing education.~~

2. [ Prior to January 1, 1999, ] three of the eight required hours shall [ ~~cover the subjects of~~ include training in ] fair housing laws and [ ~~recent developments in~~ ] state real estate laws and regulations. [ After January 1, 1999, four of the eight required hours shall include training in fair housing laws, state real estate laws and regulations, and ethics and standards of conduct. ] If the licensee

submits a notarized affidavit to the board which certifies that he does not practice residential real estate and shall not do so during the licensing term, training in fair housing shall not be required; instead such licensee shall receive training in other applicable federal and state discrimination laws and regulations. The remaining [ ~~five~~ ] hours shall be on subjects from the following list:

- a. Property rights;
- b. Contracts;
- c. Deeds;
- d. Mortgages and deeds of trust;
- e. Types of mortgages;
- f. Leases;
- g. Liens;
- h. Real property and title insurance;
- i. Investment;
- j. Taxes in real estate;
- k. Real estate financing;
- l. Brokerage and agency contract responsibilities;
- m. Real property management;
- n. Search, examination and registration of title;
- o. Title closing;
- p. Appraisal of real property;
- q. Planning subdivision developments and condominiums;
- r. Regulatory statutes;
- s. Housing legislation;
- t. Fair housing;
- u. Real Estate Board regulations;
- v. Land use;
- w. Business law;
- x. Real estate economics;
- y. Real estate investments;
- z. Federal real estate law;
- aa. Commercial real estate;
- bb. Americans With Disabilities Act;
- cc. Environmental issues impacting real estate;
- dd. Building codes and design;
- ee. Local laws and zoning;
- ff. Escrow requirements; and
- gg. [ Ethics and ] standards of conduct.

---

# Final Regulations

---

3. [ *Prior to January 1, 1999, ] licensees holding licenses in other jurisdictions must complete [ ~~a three-hour course covering three hours which shall include~~ ] fair housing laws and [ ~~recent developments in federal,~~ ] state [ ~~and local~~ ] real estate [ ~~law laws and regulations~~ ] and may substitute education completed in their jurisdiction for the remaining [ ~~five~~ ] hours required by subdivision 2 of this subsection. [ *After January 1, 1999, licensees holding licenses in other jurisdictions must complete four hours which shall include fair housing laws, state real estate laws and regulations and ethics and standards of conduct and may substitute education completed in their jurisdiction for the remaining hours required by subdivision 2 of this subsection.* ]*

4. The board may approve additional subjects at its discretion and in accordance with § 54.1-2105 of the Code of Virginia.

~~3-~~ 5. Credit for continuing education course completion is given ~~only for attendance in its entirety~~ for each class hour/clock hour as defined in 18 VAC 135-20-350.

~~4-~~ It is the responsibility of the licensee to provide ~~6-~~ 6. Licensees are responsible for retaining for three years and providing proof of continuing education ~~course completion certification~~. Proof of course completion shall be made on a form prescribed by the board. Failure to provide course completion certification as directed by the board will result in the license not being renewed ~~and/or disciplinary action pursuant to this chapter~~.

~~5-~~ 7. Instructors who are also licensees of the board may earn continuing education credit for teaching continuing education courses. ~~Verification of instructor compliance with the continuing education course required must be verified by the director or dean of the school at which the course was taught.~~

B. Applicants for renewal of a license shall meet the standards for entry as set forth in 18 VAC 135-20-30 1, 3, and 4 of this chapter.

C. The board may deny renewal of a license if the applicant has not [ *met the terms of an agreement for licensure or not* ] fully paid monetary penalties, satisfied sanctions and paid costs imposed by the board, plus any accrued interest.

## [ 18 VAC 135-20-110. Procedures for renewal.

A. The board will mail a renewal application form to the licensee ~~or registrant~~ at the last known home address. The board will mail a firm renewal notice to the business address of the firm. These notices shall outline the procedures for renewal. The board will notify the firm 30 days after the expiration of the licenses of salespersons and brokers associated with the firm. Failure to receive these notices does not relieve the licensee of the obligation to renew.

B. Prior to the expiration date shown on the license, each licensee desiring to renew the license shall return to the

board the renewal application forms and the appropriate fee as outlined in 18 VAC 135-20-120 ~~of this chapter.~~ ]

## 18 VAC 135-20-120. Fees for renewal.

A. All fees for renewals are nonrefundable, and the date of receipt by the board or its agent is the date which will be used to determine whether ~~or not~~ it is on time, ~~and~~.

B. Renewal fees are as follows:

Salesperson	\$ 46
Individual license - business entity	[ <del>\$ 100</del> \$ 46 ]
Broker	\$ 50
Concurrent broker	\$ 50
Firm	\$ 75
Branch office	\$ 45

## [ 18 VAC 135-20-150. Board discretion to deny reinstatement.

A. The board may deny reinstatement of a license if the applicant has not *met the terms of an agreement for licensure or not* fully paid monetary penalties, satisfied sanctions and paid costs imposed by the board, plus any accrued interest.

B. The board may deny reinstatement of a license for the same reasons as it may refuse initial licensure or discipline a current licensee. ]

## 18 VAC 135-20-160. Place of business.

A. Within the meaning and intent of § 54.1-2110 of the Code of Virginia, a place of business shall be an office where:

1. The principal broker, either through his own efforts or through the efforts of his employees or associates, regularly transacts the business of a real estate broker as defined in § 54.1-2100 of the Code of Virginia; and

2. The principal broker and his employees or associates can receive business calls and direct business calls to be made.

B. No place of business shall be in a residence unless it is separate and distinct from the living quarters of the residence and is accessible by the public.

C. Each place of business and each branch office shall be supervised and personally managed by an on-premises real estate broker who shall supervise only that office.

D. Every individual, partnership, association, *limited liability company*, or corporation acting as a real estate broker may display signage on the outside of each place of business maintained in the Commonwealth for the purpose of transacting business as a real estate broker. If displayed, the sign shall state the name of such individual, partnership, association, *limited liability company*, or corporation, as set forth in the license issued by the board, and contain the words "real estate," "realty" or other words or phrases designating a member of a generally recognized association or organization of real estate brokers, whichever is applicable.

E. Every principal broker shall have readily available in the main place of business the firm license, the principal broker license and the license of every salesperson and broker associated with or employed by the entity or firm. The licenses shall be displayed together, not individually, in such a manner that the public can readily determine the names of the licensees. The branch office license *and a roster of every salesperson and broker assigned to the branch office* shall be displayed in the branch office location.

F. Notice in writing, accompanied by all the current licenses, shall be given to the board in the event of any change of business name or location. Such notice shall be mailed to the board within 10 *calendar* days of the change of name or location, whereupon the board shall reissue the licenses for the unexpired period.

### **18 VAC 135-20-170. Maintenance of licenses.**

A. Salespersons and individual brokers shall at all times keep the board informed of their current home address and changes of address must be reported to the board in writing with [ 40 30 ] calendar days of such change. The board shall not be responsible for the licensee's failure to receive notices, communications and correspondence caused by the licensee's failure to promptly notify the board of any change of address. A licensee shall notify the board in a written form acceptable to the board within [ 40 30 ] *calendar* days of any change in the licensee's legal name. A licensee may use a professional name other than a legal name if that professional name is filed with the board prior to its use.

B. Salespersons and brokers shall only be issued a license to the place of business of the sole proprietorship or firm with which the salesperson or broker is affiliated or at which such licensee is employed. The license shall be issued after the sole proprietor or principal broker files a written request on a form supplied by the board.

C. Salespersons and brokers on inactive status shall receive written acknowledgment of payment from the board at the time they renew their license, but no license shall be issued since they are not affiliated with a sole proprietorship or firm.

D. When any salesperson or broker is discharged or in any way terminates his employment or affiliation or changes status as a principal or associate broker with a sole proprietorship or firm, it shall be the duty of the sole proprietor or principal broker to return the license by certified mail to the board so that it is received within 10 calendar days of the date of termination or status change. The sole proprietor or principal broker shall indicate on the license the date of termination, and shall sign the license before returning it.

E. The board, upon receipt of a transfer application or request for placement of a license on inactive status from a salesperson or associate broker, will notify the former principal broker of the licensee's change of affiliation or status at the firm's address of record. If the license has not been received by the board by the date on which above notification is issued, then it shall be the duty of the former

principal broker to return the license by certified mail to the board so that it is received within 10 calendar days of the date of the above notification.

F. All certificates of licensure in any form are the property of the Real Estate Board. Upon termination of a licensee, closing of a firm, death of a licensee, change of license status, change of licensee name or address or both, such licenses must be returned with proper instruction to the board within 10 *calendar* days.

### **18 VAC 135-20-180. Maintenance and management of escrow accounts and financial records.**

#### A. Maintenance of escrow accounts.

1. If money is to be held in escrow, each firm or sole proprietorship shall maintain in the name by which it is licensed one or more *federally insured* separate escrow accounts in a federally insured depository in Virginia into which all down payments, earnest money deposits, money received upon final settlement, rental payments, rental security deposits, money advanced by a buyer or seller for the payment of expenses in connection with the closing of real estate transactions, money advanced by the broker's ~~principal client~~ or expended on behalf of the ~~principal client~~, or other escrow funds received by him or his associates on behalf of his ~~principal client~~ or any other person shall be deposited unless all principals to the transaction have agreed otherwise in writing. The principal broker shall be held responsible for these accounts. The supervising broker and any other licensee with escrow account authority may be held responsible for these accounts. All such accounts, checks and bank statements shall be labeled "escrow" and the account(s) shall be designated as "escrow" accounts with the financial institution where such accounts are established.

2. Funds to be deposited in the escrow account will necessarily include moneys which shall ultimately belong to the licensee, but such moneys shall be separately identified in the escrow account records and shall be paid to the firm by a check drawn on the escrow account when the funds become due to the licensee. The fact that an escrow account contains money which may ultimately belong to the licensee does not constitute "commingling of funds" as set forth by [ *subdivision 5 of* ] 18 VAC 135-20-320 [ 5 ] ~~of this chapter~~, provided that there are periodic withdrawals of said funds at intervals of not more than six months, and that the licensee can at all times accurately identify the total funds in that account which belong to the licensee and the firm.

3. If escrow funds are used to purchase a certificate of deposit, the pledging or hypothecation of such certificate, or the absence of the original certificate from the direct control of the principal or supervising broker, shall constitute commingling as prohibited by 18 VAC 135-20-320 5 ~~of this chapter~~.

#### B. Disbursement of funds from escrow accounts.

---

# Final Regulations

---

1. a. Purchase transactions. Upon [ ~~acceptance~~ *the ratification* ] of a contract [ ~~(ratification)~~ ], earnest money deposits and down payments received by the principal [ *broker* ] or supervising broker or his associates [ ~~shall must~~ ] be placed in an escrow account [ *by the end of the fifth business banking day following ratification* ] and shall remain in that account until the transaction has been consummated or terminated. In the event the transaction is not consummated, the principal [ *broker* ] or supervising broker shall hold such funds in escrow until (i) all principals to the transaction have agreed in writing as to their disposition, or (ii) a court of competent jurisdiction orders such disbursement of the funds, or (iii) the broker can pay the funds to the principal to the transaction who is entitled to receive them in accordance with the clear and explicit terms of the contract which established the deposit. In the latter event, prior to disbursement, the broker shall give written notice to each principal to the transaction by either (i) hand delivery receipted for by the addressee, or (ii) by regular and certified mail, that this payment will be made unless a written protest from that principal to the transaction is received by the broker within 30 days of the delivery or mailing, as appropriate, of that notice. A broker who has carried out the above procedure shall be construed to have fulfilled the requirements of this chapter.

b. Lease transactions: security deposits. Any security deposit held by a [ ~~broker firm or sole proprietorship~~ ] shall be placed in an escrow account [ *by the end of the fifth business banking day following receipt* ]. Each such security deposit shall be treated in accordance with the ~~provisions of § 55-248.11 of the Code of Virginia, generally known as the Virginia Residential Landlord and Tenant Act~~ *security deposit provisions of the Virginia Residential Landlord and Tenant Act, Chapter 13.2 (§ 55-248.2 et seq.) of Title 55 of the Code of Virginia*, unless exempted therefrom, in which case the terms of the lease or other applicable law shall control. [ *Notwithstanding anything in this section to the contrary, unless the landlord has otherwise become entitled to receive the security deposit or a portion thereof, the security deposit shall not be removed from an escrow account required by the lease without the written consent of the tenant.* ]

c. Lease transactions: rents [ ~~and or~~ ] escrow fund advances. Unless otherwise agreed in writing by all principals to the transaction, all rents and other money paid to the licensee in connection with the lease shall be placed in an escrow account [ *by the end of the fifth business banking day following receipt* ] and remain in that account until paid in accordance with the terms of the lease and the property management agreement, as applicable.

2. a. Purchase transactions. Unless otherwise agreed in writing by all principals to the transaction, a

licensee shall not be entitled to any part of the earnest money deposit or to any other money paid to the licensee in connection with any real estate transaction as part of the licensee's commission until the transaction has been consummated.

b. Lease transactions. Unless otherwise agreed in writing by the principals to the lease [ ~~and or~~ ] property management agreement, as applicable, a licensee shall not be entitled to any part of the security deposit or to any other money paid to the licensee in connection with any real estate lease as part of the licensee's commission [ ~~until except in accordance with~~ ] the terms of the lease [ ~~have been met~~ ] or the property management agreement, as applicable. *Notwithstanding anything in this section to the contrary, unless the landlord has otherwise become entitled to receive the security deposit or a portion thereof, the security deposit shall not be removed from an escrow account required by the lease without the written consent of the tenant.* ]

3. On funds placed in an account bearing interest, written disclosure in the contract of sale or lease at the time of contract or lease writing shall be made to the principals ~~involved in~~ to the transaction regarding the disbursement of interest.

4. A licensee shall not disburse or cause to be disbursed moneys from an escrow or property management escrow account unless sufficient money is on deposit in that account to the credit of the individual client or property involved.

5. Unless otherwise agreed in writing by all principals to the transaction, expenses incidental to closing a transaction, e.g., fees for appraisal, insurance, credit report, etc., shall not be deducted from a deposit or down payment.

## C. Maintenance of financial records.

1. A complete record of financial transactions conducted under authority of the principal broker's Virginia license shall be maintained in the principal broker's place of business, or in a designated branch office. When the principal broker's office is located outside of Virginia and the firm has a branch office in Virginia, these records shall be maintained in the Virginia office. These records shall show, in addition to any other requirements of the regulations, the following information: from whom money was received; the date of receipt; the place of deposit; the date of deposit; and, after the transaction has been completed, the final disposition of the funds.

2. The principal broker shall maintain a bookkeeping system which shall accurately and clearly disclose full compliance with the requirements outlined in this section. Accounting records which are in sufficient detail to provide necessary information to determine such compliance shall be maintained.

[ 18 VAC 135-20-190. Advertising by licensees.

A. The name under which the broker does business and the manner in which the broker advertises shall not imply that the property listed or marketed by the broker for others is "for sale by owner." A broker shall not advertise in any newspaper, periodical, or sign to sell, buy, exchange, rent, or lease property in a manner indicating that the offer to sell, buy, exchange, rent, or lease such property is being made by a person not licensed as a real estate broker. No advertisement shall be inserted in any publication where only a post office box number, telephone number, or street address appears. Every broker, when advertising real estate in any newspaper or periodical, shall affirmatively and unmistakably indicate that the party advertising is a real estate broker.

A. B. Definitions. The following definitions apply unless a different meaning is plainly required by the context:

"Advertising" means any communication, whether oral or written, between a licensee or an entity acting on behalf of one or more licensees and any other person or business entity. It shall include, but is not limited to, telephonic communications, insignias, business cards, advertisements, telephone directory, listing agreements, contracts of sale, billboards, signs, letterheads, as well as radio, television, magazine, and newspaper, and internet advertisements.

"Institutional advertising" means advertising in which neither the licensed name nor any other identification of any licensed individual is disclosed, no real property is identified, and a service mark is identified.

"Service mark" means the trade name or logo, whether or not registered under any federal or state law, which is owned by an entity other than the licensee and which the licensee has obtained permission to use through agreement, license, franchise, or otherwise.

~~B. Every licensee is prohibited from advertising and marketing under the licensee's own name (except for sole proprietors trading under the principal broker's own name) in any manner offering on behalf of others to buy, sell, exchange, rent, or lease any real property.~~ C. Licensed brokers are responsible for all activities of all licensees in the real estate firm. In order to ensure the public is aware of that responsibility, this subsection is promulgated. All advertising and marketing must be under the direct supervision of the principal broker or supervising broker and in the name of the firm. Every licensee is prohibited from advertising and marketing under the licensee's own name, except for sole proprietors trading under the principal broker's own name, or in any manner offering on behalf of others to buy, sell, exchange, rent, or lease any real property. The firm's licensed name must be clearly and legibly displayed on all display signs and other types of advertising and marketing. Effective January 1, 1999, the individual licensee's name may not be larger than the firm's name.

[ C. D. ] If a licensee advertises property which he owns or in which he has any ownership interest without using the services of a licensed real estate entity, the licensee shall advertise with the notice that the owner is a real estate licensee, but such advertisement must not indicate or imply

that the licensee is operating a real estate brokerage business.

[ ~~D. E.~~ ] Service marks and institutional advertising.

1. All institutional advertising shall state that the service being advertised is real estate brokerage, and shall state affirmatively that each licensed firm or sole proprietorship displaying or using the service mark is an independently owned and operated business.

2. Any service mark constituting a part of written noninstitutional advertising shall conspicuously disclose that the licensed brokerage firm or sole proprietorship is independently owned and operated. Disclosure that the licensed brokerage firm or sole proprietorship is independently owned and operated shall not be required in the following categories of written noninstitutional advertising: ~~of specific property for sale or lease;~~

a. "For sale" and "for lease" signs located on the premises of specific property for sale or lease;

b. Advertising by a licensed firm or sole proprietorship in newspapers, magazines, or other publications of a single specific property for sale or lease when the advertisement occupies no more than 28 of the standard classified advertising lines of the newspaper, magazine, or other publications in which the advertisement is published;

c. Telephone directory advertisements disclosing that the licensed brokerage firm or sole proprietorship is independently owned and operated is required in "display" advertisements and in "in column informational" or "business card" size advertisements, or their equivalent, appearing in telephone directories.

3. In oral, noninstitutional advertising, the speaker shall disclose affirmatively the licensee's name, and except in the case of telephone communication, shall disclose that the licensed firm or sole proprietorship is independently owned and operated. ]

[ 18 VAC 135-20-200. Grounds for disciplinary action.

The board has the power to fine any licensee or registrant, and to suspend or revoke any license issued under the provisions of ~~Title 54.1~~, Chapter 21 ( § 54.1-2100 et seq.) of Title 54.1 of the Code of Virginia and the regulations of the board, where the licensee has been found to have violated or cooperated with others in violating any provision of ~~Title 54.1~~, Chapter 21 of Title 54.1 of the Code of Virginia, Chapter 1.3 ( § 6.1-2.19 et seq.) of Title 6.1 of the Code of Virginia or any regulation of the board. ]

18 VAC 135-20-210. Disclosure of interest.

A. If a licensee knows or should have known that he, any member of his family, his firm, any member of his firm, or any entity in which he has an ownership interest, is acquiring or attempting to acquire real property through purchase or lease and the licensee is a party to the transaction, the licensee must disclose that information to the owner in writing in the offer to purchase or lease.

---

# Final Regulations

---

B. A licensee selling or leasing property in which he has any *ownership* interest must disclose that he is a real estate licensee and he has an interest in the property to any purchaser or lessee in the written offer to purchase, the application, the offer to lease, or the lease, whichever occurs first.

## **18 VAC 135-20-220. Disclosure of [ agency brokerage ] relationships.**

~~A. Before the licensee has substantive discussions about specific property(ies) with a principal or prospective principal to a sale or option transaction, the licensee shall disclose to the principal or prospective principal the person(s) whom the licensee represents in a principal agency relationship. This disclosure shall be made in writing at the earliest practical time, but in any case not later than the time when specific real estate assistance is first provided. This written disclosure shall be acknowledged by the principals. Purchase transactions.~~

1. *Unless disclosure has been previously made by a licensee, a licensee shall disclose to an actual or prospective buyer or seller who is not the client of the licensee and who is not represented by another licensee and with whom the licensee has substantive discussions about a specific property or properties, the person whom the licensee represents in a brokerage relationship, as that term is defined in § 54.1-2130 of the Code of Virginia.*

2. *Except as otherwise provided in subdivision 3 of this subsection, such disclosure shall be made in writing at the earliest practical time, but in no event later than the time specific real estate assistance is first provided. Any disclosure complying with the provisions of § 54.1-2138 A of the Code of Virginia shall be deemed in compliance with this disclosure requirement.*

3. *A licensee acting as a dual or designated representative shall obtain the written consent of all clients to the transaction at the earliest practical time. Such consent shall be presumed to have been given by a client who signs a disclosure complying with the provisions of § 54.1-2139 of the Code of Virginia. Such disclosure shall be given to, and consent obtained from, (i) the buyer [ ~~or tenant~~ ] not later than the time an offer to purchase [ ~~or to lease~~ ] is presented to the licensee and (ii) the seller [ ~~or landlord~~ ] not later than the time the offer to purchase [ ~~or to lease~~ ] is presented to the seller [ ~~or landlord~~ ].*

4. *Any disclosure required by this subsection may be given in combination with other disclosures or information, but, if so, the disclosure must be conspicuous, printed in bold lettering, all capitals, underlined, or within a separate box.*

5. *Any such disclosure shall advise a prospective buyer, seller, landlord, or tenant, who is not the client of the licensee of the duties of real estate brokers and salespersons under Virginia law and that there may be*

*other relevant information concerning the transaction which may be obtained from other sources.*

~~B. All licensees shall promptly disclose their agency relationships to all actual and prospective lessors and lessees. A disclosure statement shall be included in writing in all applications for lease or in the lease itself, whichever occurs first. Lease transactions.~~

1. *Unless disclosure has been previously made by a licensee, a licensee shall disclose to an actual or prospective landlord or tenant who is not the client of the licensee and who is not represented by another licensee, that the licensee has a brokerage relationship with another party or parties to the transaction. Such disclosure shall be in writing and included in the application for lease or the lease itself, whichever occurs first. If the terms of the lease do not provide for such disclosure, the disclosure shall be made in writing not later than the signing of the lease.*

~~The~~ 2. *This disclosure requirement shall not apply to lessors and or lessees in single or multi-family residential units on leases for lease terms of less than [ ~~two~~ three ] months.*

## **18 VAC 135-20-240. Provision of records to the board.**

A licensee of the Real Estate Board shall upon request demand produce to the board or any of its agents any document, book, or record concerning any real estate transaction in which the licensee was involved, or for which the licensee is required to maintain records for inspection and copying by the board or its agents.

## **[ 18 VAC 135-20-250. Response to any inquiry of the board.**

A licensee must respond to an inquiry by the board or its agents within ~~45~~ 21 days. ]

## **18 VAC 135-20-260. Unworthiness and incompetence.**

Actions constituting unworthy and incompetent conduct include:

1. Obtaining a license by false or fraudulent representation;
2. Holding more than one license as a real estate broker or salesperson in Virginia except as provided in this chapter;
3. As a currently licensed real estate salesperson, sitting for the licensing examination for a salesperson's license;
4. As a currently licensed real estate broker, sitting for a real estate licensing examination;
5. Having been convicted or found guilty regardless of adjudication in any jurisdiction of the United States of a misdemeanor involving moral turpitude, sexual offense, drug distribution or physical injury, [ or ] any felony [ ~~, or any fair housing violation~~ ], there being no appeal pending therefrom or the time for appeal having

elapsed. Any plea of nolo contendere shall be considered a conviction for the purposes of this ~~paragraph~~ *subdivision*. The record of a conviction certified or authenticated in such form as to be admissible in evidence of the laws of the jurisdiction where convicted shall be admissible as prima facie evidence of such guilt;

6. Failing to inform the board in writing within 30 days of pleading guilty or nolo contendere or being convicted or found guilty regardless of adjudication of any felony or of a misdemeanor involving moral turpitude, sexual offense, drug distribution or physical injury;

7. Having been found in a court or an administrative body of competent jurisdiction to have violated the Virginia Fair Housing Act, the Fair Housing Laws of any jurisdiction of the United States including without limitation Title VIII of the Civil Rights Act of 1968 (82 Stat. 73), or the Civil Rights Act of 1866 (14 Stat. 27), there being no appeal therefrom or the time for appeal having elapsed; ~~and~~

8. Failing to act as a real estate broker or salesperson in such a manner as to safeguard the interests of the public, ~~or otherwise~~, *and*

9. Engaging in improper, fraudulent, or dishonest conduct.

### 18 VAC 135-20-270. Conflict of interest.

Actions constituting a conflict of interest include:

1. Being employed by, affiliated with or receiving compensation from a real estate broker other than the licensee's principal broker, without the written consent of the principal broker;

2. Acting for more than one ~~party~~ *client* in a transaction without *first obtaining* the written consent of all ~~principals~~ *for whom the licensee acts clients as provided by § 54.1-2139 of the Code of Virginia*;

3. Acting as an ~~agent for any principal in a real estate transaction~~ *a standard agent or independent contractor for any client* outside the licensee's brokerage firm(s) or sole proprietorship(s).

### 18 VAC 135-20-280. Improper brokerage commission.

Actions resulting in an improper brokerage commission include:

1. Offering to pay or paying a commission or other valuable consideration to any person for acts or services performed in violation of ~~Title 54.1~~, Chapter 21 (*§ 54.1-2100 et seq.*) of Title 54.1 of the Code of Virginia, or this chapter; provided, however, that referral fees and shared commissions may be paid to any real estate entity licensed in this or another jurisdiction, or to any referral entity in the United States, the members of which are brokers licensed in this or another jurisdiction and which only disburses commissions or referral fees to its licensed member brokers;

2. Accepting a commission or other valuable consideration, as a real estate salesperson or associate broker, for the performance of any of the acts specified in ~~Title 54.1~~, Chapter 21 (*§ 54.1-2100 et seq.*) of Title 54.1 of the Code of Virginia or the regulations of the board, from any person except the licensee's principal broker at the time of the transaction;

3. Receiving a fee or portion thereof including a referral fee or a commission or other valuable consideration for services required by the terms of the real estate contract when such costs are to be paid by either one or both principals to the transaction unless such fact is revealed in writing to the principal(s) prior to the time of ordering or contracting for the services;

4. Offering or paying any money or other valuable consideration for services required by the terms of the real estate contract to any party other than the principals to a transaction which results in a fee being paid to the licensee; without such fact being revealed in writing to the principal(s) prior to the time of ordering or contracting for the services;

5. Making a listing contract or lease which provides for a "net" return to the seller/lessor, leaving the licensee free to sell or lease the property at any price he can obtain in excess of the "net" price named by the seller/lessor; and

6. Charging money or other valuable consideration to or accepting or receiving money or other valuable consideration from any person or entity other than the licensee's ~~principal client~~ *for expenditures made on behalf of that principal client without the written consent of the principal client.*

### 18 VAC 135-20-290. Improper dealing.

Actions constituting improper dealing include:

1. ~~Making an exclusive agency contract or an exclusive right to sell contract which does not have~~ *Entering a brokerage relationship that does not specify a definite termination date;*

2. Offering real property for sale or for lease without the knowledge and consent of the owner or the owner's authorized ~~agent representative~~, or on any terms other than those authorized by the owner or the owner's authorized ~~agent representative~~;

3. Placing a sign on any property without the consent of the owner of the property or the owner's authorized [~~agent representative~~]; [~~and~~]

4. Causing any advertisement for sale, rent, or lease to appear in any newspaper, periodical, or sign without including in the advertisement the name of the firm or sole proprietorship [~~and~~].

~~[ 5. Acting in the capacity of settlement agent in a real estate closing by a salesperson, except:~~

---

# Final Regulations

---

- ~~a. When the salesperson is under the direct supervision of the principal/supervising broker;~~
- ~~b. When the salesperson is under the direct supervision of a licensed officer of the corporation or a licensed partner of the partnership under which the salesperson is licensed;~~
- ~~c. When the settlement agent is a member of the Virginia State Bar or a law firm, the members of which are members of the Virginia State Bar; or~~
- ~~d. When the settlement agent is a title insurance company or an agency thereof or a firm regularly engaged in the business of closing real estate transactions. ]~~

## 18 VAC 135-20-300. Misrepresentation/omission.

Actions constituting misrepresentation or omission, or both, include:

1. Using "bait and switch" tactics by advertising or offering real property for sale or rent with the intent not to sell or rent at the price or terms advertised, unless the advertisement or offer clearly states that the property advertised is limited in specific quantity and the licensee ~~or registrant~~ did in fact have at least that quantity for sale or rent;
- ~~2. Failing to disclose any material information in a timely manner to a prospective purchaser/lessee, or seller/lessor, related to the property, the physical condition of the property, or the transaction reasonably available to the licensee.~~
2. *Failure by a licensee representing a seller or landlord as a standard agent to disclose in a timely manner to a prospective purchaser or tenant all material adverse facts pertaining to the physical condition of the property which are actually known by the licensee;*
3. Failing as a licensee to tender promptly to the buyer and seller every written offer, every written counteroffer, and every written rejection to purchase, option or lease obtained on the property involved;
4. *Failure by a licensee acting as a standard agent to disclose in a timely manner to the licensee's client all material facts related to the property or concerning the transaction [ ~~which are reasonably available to the licensee when the failure to so disclose would constitute failure by the licensee to exercise ordinary care as defined in the brokerage agreement~~ ];*
5. *Notwithstanding the provisions of subdivision 4 of this section, a licensee acting as a dual representative shall not disclose to one client represented in the dual representation confidential information relating to the transaction obtained during the representation of another client in the same dual representation unless otherwise provided by law;*

- ~~4. 6. Failing to include the complete terms and conditions of the real estate transaction in any lease or offer to purchase;~~
- ~~5. 7. Failing to include in any application, lease, or offer to purchase identification of all those holding any deposits;~~
- ~~6. 8. Knowingly making any false statement or report, or willfully misstating the value of any land, property, or security for the purpose of influencing in any way the action of any lender upon:~~
  - a. Applications, advance discounts, purchase agreements, repurchase agreements, commitments or loans;
  - b. Changes in terms or extensions of time for any of the items listed in this subdivision ~~6 8~~ whether by renewal, deferment of action, or other means without the prior written consent of the principals to the transaction;
  - c. Acceptance, release, or substitution of security for any of the items listed in subdivision ~~6 8~~ a of this section without the prior written consent of the principals to the transaction.
- ~~7. 9. Making any misrepresentation; and~~
- ~~8. 10. Making a false promise through agents, salespersons, advertising, or other means.~~

## 18 VAC 135-20-310. Delivery of instruments.

Actions constituting improper delivery of instruments include:

1. Failing to make prompt delivery to each principal to a transaction, complete and legible copies of any written *disclosures required by §§ 54.1-2138 and 54.1-2139 of the Code of Virginia*, listings, lease, offers to purchase, counteroffers, addenda and ratified agreements, and other documentation required by the agreement;
2. Failing to provide in a timely manner to all principals to the transaction written notice of any material changes to the transaction;
3. Failing to deliver to the seller and buyer, at the time a real estate transaction is completed, a complete and accurate statement of receipts and disbursements of moneys received by the licensee, duly signed and certified by the principal or supervising broker or his authorized agent; provided, however, if the transaction is closed by a settlement agent other than the licensee or his broker, and if the disbursement of moneys received by the licensee is disclosed on the applicable settlement statement, the licensee shall not be required to provide the separate statement of receipts and disbursements; and
4. Refusing or failing without just cause to surrender to the rightful owner, upon demand, any document or instrument which the licensee possesses.



## [ 18 VAC 135-20-320. Recordkeeping and escrow funds.

Actions constituting improper recordkeeping and maintenance of escrow funds include:

1. Failing, as a principal or supervising broker, to retain for a period of three years from the date of the closing or ratification, if the transaction fails to close, a complete and legible copy of each *disclosure of a brokerage relationship and each executed* contract, agreement, and closing statement related to a real estate transaction, ~~and all other documents material to that transaction in the broker's control or possession;~~
2. Having received moneys on behalf of others and failed to maintain a complete and accurate record of such receipts and their disbursements for a period of three years from the date of the closing or termination of a lease or conclusion of the licensee's involvement in the lease;
3. Failing, within a reasonable time, to account for or to remit any moneys coming into a licensee's possession which belong to others;
4. Accepting any note, nonnegotiable instrument, or anything of value not readily negotiable, as a deposit on a contract, offer to purchase, or lease, without acknowledging its acceptance in the agreement;
5. Commingling the funds of any person by a principal or supervising broker or his employees or associates or any licensee with his own funds, or those of his corporation, firm, or association; and
6. Failure to deposit escrow funds in an account or accounts designated to receive only such funds as required by this chapter (see 18 VAC 135-20-180 A 1). ]

## 18 VAC 135-20-350. Definitions.

~~As used in this chapter, unless a different meaning is plainly required by the context:~~ *The following words and terms, when used in this part, unless a different meaning is provided or is plainly required by the context, shall have the following meanings:*

~~"Accredited colleges, universities and university, college, community colleges, college, or other school or educational institution,"~~ as used in § 54.1-2105 ~~2 B 1 a~~ of the Code of Virginia, means those accredited institutions of higher learning approved by the Virginia Council of Higher Education or listed in the Transfer Credit Practices of Designated Educational Institutions, published by the American Association of Collegiate Registrars and Admissions Officers.

~~"Classroom~~ *Class hour/clock hour"* means 50 minutes.

*"Equivalent course"* means any course encompassing the basic educational curriculum of Virginia courses and approved by the board.

*"Proprietary school"* means (i) a privately owned school, (ii) a real estate professional association, or (iii) a related entity, which is not under the authority of the Department of

Education, but approved by the Real Estate Board to teach real estate courses.

*"Provider"* means an accredited university, college, community college [ , or ] high school offering adult distributive education courses, or a proprietary school.

## 18 VAC 135-20-360. Proprietary school standards: ~~educational environment;~~ instructor qualifications; ~~courses and course requirements.~~

A. Every applicant to the Real Estate Board for a proprietary school certificate shall meet the standards provided in ~~this section~~ § 54.1-2105 of the Code of Virginia.

~~B. All schools must be in a building conducive to academic purposes. Facilities must meet necessary building code standards, fire safety standards, and sanitation standards.~~

~~C. B.~~ Every applicant to the Real Estate Board for approval as an instructor shall have one of the following qualifications:

~~[ 1. Baccalaureate degree in real estate, or in business with a concentration in real estate or a closely related field; ]~~

~~[ 2- 1. ]~~ Baccalaureate degree, a Virginia real estate [ broker's] license, and two years of discipline-free active real estate experience within the past five years;

~~[ 3- 2. ]~~ ~~Seven~~ Five years of discipline-free active experience acquired in the real estate field in the past ~~40~~ seven years and an active Virginia broker's license; or

~~[ 4- 3. ]~~ Qualified experts in a specific field of real estate who will teach only in the area of their expertise. For example, a licensed real estate appraiser, with at least five years of active appraisal experience in Virginia, may be approved to teach Real Estate Appraisals. Such applicants will be required to furnish proof of their expertise including, but not limited to, educational transcripts, professional certificates and letters of reference which will verify the applicant's expertise.

~~D. All real estate~~ C. *Prelicense* courses must be acceptable to the board and are required to have a monitored, final written examination.

~~1. Prelicensing courses may be completed by correspondence if such courses are not available in a reasonable proximity to the applicant's residence or business location in the Commonwealth. Students seeking board approval to take prelicensing correspondence courses must make a written request to the board in which they specify that the classroom course(s) are not available in a reasonable geographical proximity to the applicant's residence or business location.~~

2. Those schools which propose to offer prelicensing correspondence courses (Principles and Practices of Real Estate, Real Estate Brokerage, Real Estate Finance, Real Estate Law or Real Estate Appraisal, etc.) must submit a

---

# Final Regulations

---

request, in writing, to the board prior to offering the course(s) and supply the following information:

- ~~a-~~ 1. Course content. All Principles and Practices of Real Estate courses must include the 25 topic areas specified in 18 VAC 135-20-400. All requests to offer broker courses must include a ~~comparable~~ course syllabus ~~from an accredited university, college or community college to establish equivalency.~~ acceptable to the board;
  - ~~b-~~ 2. Name of the course's text and any research materials used for study assignments-;
  - ~~c-~~ 3. Description of any research assignments-;
  - ~~d-~~ 4. Copies of test or quizzes-;
  - e. 5. Information explaining how the "Principles" course will require 60 hours of study, or how each broker related course will require 45 hours of study, in compliance with § 54.1-2105 of the Code of Virginia-; and
  - f. 6. Information about recordkeeping for ~~this~~ the type of course delivery.
- ~~3. Correspondence courses must have a final, monitored written examination which is administered at the school's main, or branch, site.~~

D. Providers of continuing education courses shall submit all subjects to the board for approval prior to initially offering the course. Correspondence and other distance learning courses offered by an approved provider must include appropriate testing procedures to verify completion of the course. [ The board shall approve courses and the number of hours approved for each course based on the relevance of the subject to the performance of the duties set forth in §§ 54.1-2100 and 54.1-2101 of the Code of Virginia. ]

E. All schools must establish and maintain a record for each student. The record shall include: the student's name and address, the course name and clock hours attended, the course syllabus or outline, the name or names of the instructor, [ and ] the date of successful completion [ , and the board's course code ]. Records shall be available for inspection during normal business hours by authorized representatives of the board. Schools must maintain all student and class records for a minimum of five years.

F. All schools must provide each student with a certificate of course completion or other document that the student may use as proof of course completion. The certificate or other document shall contain the hours of credit completed.

## 18 VAC 135-20-370. Fees.

A. The application fee for original certificate for a proprietary school shall be \$90.

B. The renewal fee for proprietary school certificates expiring ~~annually~~ biennially on June 30 shall be \$45.

C. If the requirements for renewal of a proprietary school certificate, including receipt of the fee of by the board, are not

completed within 30 days of the expiration date noted on the certificate, a reinstatement fee of \$250 is required. A certificate may be reinstated for up to one year following the expiration date with payment of the reinstatement fee. After one year, the certificate may not be reinstated under any circumstances and the applicant must meet all requirements and apply as a new applicant.

D. The application for original instructor certificate shall be [ ~~\$145~~ \$100 ].

E. The renewal fee for an instructor certificate expiring biennially on June 30 shall be [ ~~\$145~~ \$50 ].

F. If the requirements for renewal of an instructor certificate, including receipt of the fee by the board, are not completed within 30 days of the expiration date on the certificate, a reinstatement fee of \$250 is required. A certificate may be reinstated for up to one year following the expiration date with payment of the reinstatement fee. After one year, the certificate may not be reinstated under any circumstances and the applicant must meet all requirements and apply as a new applicant.

~~G-~~ G. The board in its discretion may deny renewal of a certificate. Upon such denial, the certificate holder may request that a hearing be held.

## 18 VAC 135-20-380. Posting school certificate of approval and ~~registration~~ instructor certificates.

[ Copies of ] school certificates of approval ~~and registration~~, and instructor certificates [ , if applicable, ] must be [ ~~displayed in each approved school facility in a conspicuous place readily accessible to the public available at the location a course is taught~~ ].

## 18 VAC 135-20-390. Withdrawal of approval.

The board may withdraw approval of any school or instructor for the following reasons:

1. The school, instructors, ~~or~~ courses, or subjects no longer meet the standards established by the board.
2. The school or instructor solicits information from any person for the purpose of discovering past examination questions or questions which may be used in future examinations.
3. The school or instructor distributes to any person copies of examination questions, or otherwise communicates to any person examination questions, without receiving the prior written approval of the copyright owner to distribute or communicate those questions.
4. The school, through an agent or otherwise, advertises its services in a fraudulent, deceptive or misrepresentative manner.
5. Officials, instructors or designees of the school sit for a real estate licensing examination for any purpose other than to obtain a license as a broker or salesperson.

**[ 18 VAC 135-20-400. Course content of real estate principles and practices.**

The following shall be included in the four-semester-hour or six-quarter-hour course which shall not have less than 60 ~~classroom~~ class hours:

1. Economy and social impact of real estate
2. Real estate market and analysis
3. Property rights
4. Contracts
5. Deeds
6. Mortgages and deeds of trust
7. Types of mortgages
8. Leases
9. Liens
10. Home ownership
11. Real property and title insurance
12. Investment
13. Taxes in real estate
14. Real estate financing
15. Brokerage and agency contract responsibilities
16. Real estate marketing
17. Real property management
18. Search, examination, and registration of title
19. Title closing
20. Appraisal of residential and income producing property
21. Planning subdivision developments and condominiums
22. Regulatory statutes
23. Housing legislation
24. Fair housing statutes
25. Real Estate Board regulations ]

**18 VAC 135-20-410. ~~Related subjects~~ Broker courses.**

A. *Brokerage shall be a required specific course with three semester hours or six quarter hours [ , but not less than 45 class hours, ] constituting a complete course.*

B. "Related subjects," as referred to in § 54.1-2105 of the Code of Virginia, shall be real estate related and shall include, but are not limited to, courses in property management, land planning and land use, business law, real estate economics, and real estate investments.

C. *No more than [ ~~three semester hours or four quarter~~ 45 class ] hours of broker-related courses shall be accepted in lieu of specific broker courses.*

D. *Schools intending to offer equivalent broker courses must submit to the board for approval a copy of the syllabus of the particular course with a cover letter requesting approval.*

**18 VAC 135-20-420. ~~Required specific course.~~ (Repealed.)**

~~Brokerage shall be a required specific course with three semester hours or six quarter hours constituting a complete course.~~

**18 VAC 135-20-430. ~~Credit for broker-related courses.~~ (Repealed.)**

~~No more than three semester hours or four quarter hours of broker-related courses shall be accepted in lieu of specific broker courses.~~

**18 VAC 135-20-440. ~~Broker-related course approval procedure.~~ (Repealed.)**

~~Schools intending to offer equivalent broker courses must submit to the board for approval a copy of the syllabus of the particular course with a cover letter requesting approval.~~

**NOTICE:** The forms used in administering 18 VAC 135-20-10 et seq., Virginia Real Estate Board Licensing Regulations, are not being published due to the large number; however, the name of each form is listed below. The forms are available for public inspection at the Real Estate Board, Department of Professional and Occupational Regulation, 3600 West Broad Street, Richmond, Virginia, telephone (804) 367-8552 or at the office of the Registrar of Regulations, General Assembly Building, 2nd Floor, Richmond, Virginia.

FORMS

- Real Estate Application, VREB/Fm 2 (12/93).
- Real Estate Salesperson Application.
- ~~Real Estate Concurrent Broker Application.~~
- ~~Real Estate Business License Application.~~
- ~~Real Estate Branch Office Application.~~
- ~~Real Estate Transfer Application, VREB Fm 1 (Apr 95).~~
- ~~Real Estate Activate Application, VREB Fm 2 (Apr 95).~~
- Concurrent Broker Acknowledgment Form (6/97).
- Experience Verification Form (5/97).
- Activate/Transfer/Concurrent Application (6/97).
- Salesperson License by Reciprocity Application (3/97).
- Broker License by Reciprocity Application (3/97).
- Branch Office License Application (2/97).

---

# Final Regulations

---

*Supervising Broker Appointment/Change Form (3/97).*

*Firm Principal Broker/Officer Change Form (3/97).*

*Firm Name/Address Change Form (3/97).*

*Firm License Application (3/97).*

VA.R. Doc. No. R96-373; Filed June 2, 1998, 11:57 a.m.

---

# FORMS

---

## DEPARTMENT OF MINES, MINERALS AND ENERGY

**EDITOR'S NOTICE:** The following forms have been amended or repealed by the Department of Mines, Minerals and Energy. The forms are available for public inspection at the Department of Mines, Minerals and Energy, Ninth Street Office Building, 202 North 9th Street, Richmond, VA 23219. Copies of the forms may be obtained from Cheryl Cashman, Department of Mines, Minerals and Energy, Ninth Street Office Building, 202 North 9th Street, Richmond, VA 23219, telephone (804) 692-3213.

Title of Regulation: **4 VAC 25-130-10 et seq. Coal Surface Mining Reclamation Regulations.**

DMLR-AML-122, Consent for Right of Entry—Exploratory, Rev. ~~12/85~~ 3/98.

DMLR-AML-123, Consent for Right of Entry—Construction—~~Lien~~, Rev. ~~12/85~~ 3/98.

~~DMLR-AML-124, Consent for Right of Entry—Construction—  
No Lien, Rev. 12/85.~~

DMLR-AML-177, Consent for Right of Entry—  
Ingress/Egress, Rev. ~~3/88~~ 3/98.

DMLR-PT-255, Irrevocable Standby Letter of Credit, Rev. ~~8/97~~ 7/98.



COMMONWEALTH OF VIRGINIA  
 DEPARTMENT OF MINES, MINERALS AND ENERGY  
 DIVISION OF MINED LAND RECLAMATION  
 P. O. DRAWER 900; BIG STONE GAP, VA 24219  
 TELEPHONE: (540) 523-8206

**CONSENT FOR RIGHT OF ENTRY - Exploratory**  
 (Abandoned Mine Land Program)

<b>Project</b>				<b>Grant</b>	
<b>Owner of Record</b>				Acreage	
County Map No.		Parcel No.		<b>Property Interest*</b>	
City/County		Deed Book		Page(s)	

As the legal and rightful Owner of record (or authorized agent acting on behalf thereof) of the Property, identified in the aforementioned records, I (we) do hereby grant (and commit such heirs, successors, and assigns herefrom) to the Department of Mines, Minerals and Energy, Division of Mined Land Reclamation (hereinafter referred to as "Division") and to the U. S. Department of the Interior, Office of Surface Mining Reclamation and Enforcement (hereinafter referred to as "Office"), their agents, employees, or contractors, the right to enter upon the Property at the Division's and Office's own risk, cost and expense, for the purpose of determining the existence of adverse effects of past coal mining practices, and to determine the feasibility of restoration, reclamation, abatement, control, or prevention of such adverse effects.

Entry and reclamation and abatement work, if any, performed by the Division or Office, their agents, employees, or contractors, is pursuant to the authority granted in the **Virginia Coal Surface Mining Control and Reclamation Act of 1979** (Act: §45.1-260 *et seq.* of the **Code of Virginia**), as amended and the regulations promulgated thereunder (Subchapter VR, Part 4 VAC 25-130-874 and Part 4 VAC 25-130-877 *et seq.*), and Title IV of the **Surface Mining Control and Reclamation Act of 1977** (Federal Act: 30 U.S.C. 1231 *et seq.*).

I (we) give this right of entry consent to enter the Property for the length of time necessary to complete the exploratory work described in the aforesaid grant between the Office and the Division, to accomplish the reclamation project located on the Property, subject to the Owner's continued ownership and use of the property.

In granting consent to this entry, the Owner does not waive any rights conferred upon it by virtue of the language contained in the Act, as amended and the regulations promulgated thereunder. The Division or Office does not waive its rights or responsibilities conferred by the Act and Title IV of the Federal Act.

Nothing contained herein will be deemed to be an expressed or implied waiver of the sovereign immunity of the Commonwealth or its duly authorized representatives, agents and/or employees.

As consideration for the granting of this consent to enter upon said Property, the Division and Office agree that the following provisions are to be a part of the Consent for Right of Entry:

1. All Activity conducted and authorized by the Division and Office on the Property will be at the expense of the Division and Office.

\* Property Interest: Surface only, Mineral Only, Lessee, or Fee

**Division of Mined Land Reclamation**  
Consent for Right of Entry - Exploratory (AML Program)

- 2. The entry upon the Property by the Division and Office, their agents, employees and contractors is for the convenience and purposes of the Division and Office and is not upon any business with or for the Owner.
- 3. The Division acknowledges that while the exploration activity is being conducted on the Property, the Owner will not be excluded from carrying on normal activities, including the movement of machinery and equipment.
- 4. The Division agrees that they will require their contractors, subcontractors, or both, who enter upon the Property to perform the exploration activity, to maintain insurance coverage to protect the Owner and the Division from liability for negligent acts or omissions on the part of said contractor, subcontractor, or both, as is required under the Division's contract for the exploration activity, and upon request by the Owner, the Division will furnish evidence of such insurance to the Owner.
- 5. The Division agrees to provide without cost, if requested by the Owner, a copy of the final study results and reports as submitted to the Division by the Division's contractor(s).
- 6. This Agreement shall be binding upon and shall inure to the benefit of the heirs, successors, and assigns of the parties.

7. Additional Conditions:

a.
b.
c.
d.

WITNESS the following signatures on this \_\_\_\_\_ day of \_\_\_\_\_, 19 \_\_\_\_ .

By: \_\_\_\_\_

Witness: \_\_\_\_\_

\_\_\_\_\_  
**Owner /Authorized Agent**

By: \_\_\_\_\_

Date: \_\_\_\_\_

**Abandoned Mine Land Manager**  
**Department of Mines, Minerals and Energy**  
**Division of Mined Land Reclamation**



COMMONWEALTH OF VIRGINIA  
 DEPARTMENT OF MINES, MINERALS AND ENERGY  
 DIVISION OF MINED LAND RECLAMATION  
 P. O. DRAWER 900; BIG STONE GAP, VA 24219  
 TELEPHONE: (540) 523-8206

**CONSENT FOR RIGHT OF ENTRY - Construction**  
 (Abandoned Mine Land Program)

<b>Project</b>		<b>Grant</b>	
----------------	--	--------------	--

<b>Owner of Record</b>		Acreage	
County Map No.	Parcel No.	<b>Property Interest</b> <sup>1</sup>	
City/County		Property Status <sup>2</sup>	
Deed Book		Page(s)	

As the legal and rightful Owner of record (or authorized agent acting on behalf thereof) of the Property, identified in the aforementioned records, I (we) do hereby grant (and commit such heirs, successors, and assigns herefrom) to the Department of Mines, Minerals and Energy, Division of Mined Land Reclamation (hereinafter referred to as "Division") and to the U. S. Department of the Interior, Office of Surface Mining Reclamation and Enforcement (hereinafter referred to as "Office"), their agents, employees, or contractors, the right to enter upon the Property at the Division's and Office's own risk, cost and expense, to restore, reclaim, abate, control, or prevent the adverse effects of coal mining practices, and to do all things necessary or expedient to protect the public health, safety, or general welfare.

Entry and reclamation and abatement work, if any, performed by the Division or Office, their agents, employees, or contractors, is pursuant to the authority granted in the **Virginia Coal Surface Mining Control and Reclamation Act of 1979** (Act: §45.1-260 *et seq.* of the **Code of Virginia**), as amended and the regulations promulgated thereunder (Subchapter VR, Part 4 VAC 25-130-874 and Part 4 VAC 25-130-877 *et seq.*), and Title IV of the **Surface Mining Control and Reclamation Act of 1977** (Federal Act: 30 U.S.C. 1231 *et seq.*).

I (we) give this right of entry consent to enter the Property for the length of time necessary to complete the construction work described in the aforesaid grant between the Office and the Division, to accomplish the reclamation project located on the property, subject to the Owner's continued ownership and use of the property.

In granting consent to this entry, the Owner does not waive any rights conferred upon it by virtue of the language contained in the Act, as amended and the regulations promulgated thereunder. The Division or Office does not waive its rights or responsibilities conferred by the Act and Title IV of the Federal Act.

<b>PROPERTY/LIEN STATUS - (Check the applicable clause.)</b>	
<input type="checkbox"/>	Exempt from lien.
<input type="checkbox"/>	I understand that a lien may be placed against the property if the reclamation work performed results in a significant increase in the market value of the property. The lien, if appropriate, will be determined and filed in accordance with Virginia Regulations Part 4 VAC 25-130-882.13 <i>et seq.</i> , and § 408 of the Federal Act.
<input type="checkbox"/>	Any <b>lien</b> that may be imposed in accordance with Virginia Regulations Part 4 VAC 25-130-882.13 <i>et seq.</i> , and § 408 of the Federal Act <b>has been waived</b> by the Division, as provided under the Act.

<sup>1</sup> **Property Interest:** Surface only, Mineral Only, Lessee, Fee; or Borrow/Disposal area.

<sup>2</sup> **Property Status:** N = Not lienable; L = subject to lien; W = lien waived; and A = awaiting appraisal.



**Division of Mined Land Reclamation**  
Consent for Right of Entry - Construction (AML Program)

Nothing contained herein will be deemed to be an expressed or implied waiver of the sovereign immunity of the Commonwealth or its duly authorized representatives, agents and/or employees.

As consideration for the granting of this consent to enter upon said Property, the Division and Office agree that the following provisions are to be a part of the Consent for Right of Entry:

1. All activity conducted and authorized by the Division and Office on the Property will be at the expense of the Division and Office.
2. The entry upon the Property by the Division and Office, their agents, employees and contractors is for the convenience and purposes of the Division and Office and is not upon any business with or for the Owner.
3. The Division acknowledges that while the construction activity is being conducted on the Property, the Owner will not be excluded from carrying on normal activities, including the movement of machinery and equipment.
4. The Division agrees that they will require their contractors, subcontractors, or both, who enter upon the Property to perform the construction activity, to maintain insurance coverage to protect the Owner and the Division from liability for negligent acts or omissions on the part of said contractor, subcontractor, or both, as is required under the Division's contract for the construction activity, and upon request by the Owner, the Division will furnish evidence of such insurance to the Owner.
5. The Division accepts all of said premises and property and the structures, machinery, equipment, and facilities therein and thereon in the condition they now are and from time to time hereafter may be. Provided that this paragraph does not affect enforcement jurisdiction of the Division or Office under the Act and Title V of the Federal Act for any active mining operations occurring on such premises.
6. This Agreement shall be binding upon and shall inure to the benefit of the heirs, successors and assigns of the parties.
7. Additional Conditions:

a.
b.
c.
d.

**WITNESS the following signatures on this \_\_\_\_\_ day of \_\_\_\_\_, 19 \_\_\_\_ .**

**By:** \_\_\_\_\_ **Witness:** \_\_\_\_\_

\_\_\_\_\_  
**Owner/Authorized Agent**

**By:** \_\_\_\_\_ **Date:** \_\_\_\_\_

**Abandoned Mine Land Manager**  
Department of Mines, Minerals and Energy  
Division of Mined Land Reclamation



COMMONWEALTH OF VIRGINIA  
 DEPARTMENT OF MINES, MINERALS AND ENERGY  
 DIVISION OF MINED LAND RECLAMATION  
 P. O. DRAWER 900; BIG STONE GAP, VA 24219  
 TELEPHONE: (540) 523-8206

**CONSENT FOR RIGHT OF ENTRY - Ingress/Egress**

(Abandoned Mine Land Program)

<b>Project</b>				<b>Grant</b>		
<b>Owner of Record</b>				Acreage		
County Map No.		Parcel No.		<b>Property Interest*</b>		
City/County			Deed Book		Page(s)	

As the legal and rightful Owner of record (or authorized agent acting on behalf thereof) of the Property, identified in the aforementioned records, I (we) do hereby grant (and commit such heirs, successors, and assigns herefrom) to the Department of Mines, Minerals and Energy, Division of Mined Land Reclamation (hereinafter referred to as "Division") and to the U. S. Department of the Interior, Office of Surface Mining Reclamation and Enforcement (hereinafter referred to as "Office"), their agents, employees, or contractors, the right of ingress and egress on the Property at the Division's and Office's own risk, cost and expense, to restore, reclaim, abate, control, or prevent the adverse effects of coal mining practices, and to do all things necessary or expedient to protect the public health, safety, or general welfare.

Entry and reclamation and abatement work, if any, performed by the Division or Office, their agents, employees, or contractors, is pursuant to the authority granted in the **Virginia Coal Surface Mining Control and Reclamation Act of 1979** (Act: §45.1-260 *et seq.* of the **Code of Virginia**), as amended and the regulations promulgated thereunder (Subchapter VR, Part 4 VAC 25-130-874 and Part 4 VAC 25-130-877 *et seq.*), and Title IV of the **Surface Mining Control and Reclamation Act of 1977** (Federal Act: 30 U.S.C. 1231 *et seq.*).

I (we) give this right of entry consent to enter the Property for the length of time necessary to complete the construction work described in the aforesaid grant between the Office and the Division, to accomplish the reclamation project located on the Property, subject to the Owner's continued ownership and use of the property.

In granting consent to this entry, the Owner does not waive any rights conferred upon it by virtue of the language contained in the Act, as amended and the regulations promulgated thereunder. The Division or Office does not waive its rights or responsibilities conferred by the Act and Title IV of the Federal Act.

Nothing contained herein will be deemed to be an expressed or implied waiver of the sovereign immunity of the Commonwealth or its duly authorized representatives, agents and/or employees.

As consideration for the granting of this consent to enter upon said Property, the Division and Office agree that the following provisions are to be a part of the Consent for Right of Entry:

1. All Activity conducted and authorized by the Division and Office on the Property will be at the expense of the Division and Office.
2. The entry upon the Property by the Division and Office, their agents, employees and contractors is for the convenience and purposes of the Division and Office and is not upon any business with or for the Owner.

\* Property Interest: Surface only, Mineral Only, Lessee, or Fee

**Division of Mined Land Reclamation**  
Consent for Right of Entry - Ingress/Egress (AML Program)

- 3. The Division acknowledges that while the construction activity is being conducted on the Property, the Owner will not be excluded from carrying on normal activities, including the movement of machinery and equipment.
- 4. The Division agrees that they will require their contractors, subcontractors, or both, who enter upon the Property to perform the construction activity, to maintain insurance coverage to protect the Owner and the Division from liability for negligent acts or omissions on the part of said contractor, subcontractor, or both, as is required under the Division's contract for the construction activity, and upon request by the Owner, the Division will furnish evidence of such insurance to the Owner.
- 5. The Division will, at its expense, substantially restore the Property to its condition prior to changes made by the Division, its agents, contractors or representatives unless the Division and the Owner agree otherwise.
- 6. This Agreement shall be binding upon and shall inure to the benefit of the heirs, successors and assigns of the parties.
- 7. Additional Conditions:

a.
b.
c.
d.

**WITNESS the following signatures on this \_\_\_\_\_ day of \_\_\_\_\_, 19 \_\_\_\_ .**

**By:** \_\_\_\_\_

**Witness:** \_\_\_\_\_

\_\_\_\_\_  
**Owner /Authorized Agent**

**By:** \_\_\_\_\_

**Date:** \_\_\_\_\_

**Abandoned Mine Land Manager**  
Department of Mines, Minerals and Energy  
Division of Mined Land Reclamation

**IRREVOCABLE STANDBY LETTER OF CREDIT**

**Irrevocable Standby Letter of Credit  
Number:** \_\_\_\_\_

Date: \_\_\_\_\_

Commonwealth of Virginia  
Department of Mines, Minerals and Energy  
Division of Mined Land Reclamation  
Post Office Drawer 900  
Big Stone Gap, Virginia 24219

	(Name Address & Telephone Number)
--	---

Gentlemen:

In accordance with Section 45.1-241(C) of the **Code of Virginia**, we hereby issue our **Irrevocable Letter of Credit** (on certain designated funds) in your favor for the account of (must state the exact name that appears on the permit) \_\_\_\_\_, Permit Number \_\_\_\_\_ for the sum or sums not to exceed a total of \_\_\_\_\_ U.S. Dollars (\$ USD \_\_\_\_\_) available by your draft(s) on us at sight.

This Letter of Credit will expire at our counters on \_\_\_\_\_.

It is a condition of this Letter of Credit that it will be automatically extended for additional periods of one (1) year from the present or each future expiration date unless we have notified you in writing, not less than thirty (30) days before the annual expiration date, that we elect not to renew this Letter of Credit. The Notice of such election shall be sent by registered mail, return receipt requested, and received by the Director of the Division of Mined Land Reclamation (hereafter referred to as "DMLR"), Post Office Drawer 900; Big Stone Gap, Virginia 24219 (or any change of address provided by the DMLR hereafter to us); or we may hand deliver the written Notice to, and obtain a written, dated receipt from the Director of DMLR at the DMLR's Big Stone Gap office.

This credit is subject to the **Uniform Customs and Practice for Documentary Credits** (1993 Revision) International Chamber of Commerce (Publication No. 500).

We further agree that unless expressly stated otherwise herein, the terms and obligations represented by this credit shall be governed by the Uniform Commercial Code of the Commonwealth of Virginia and/or any other pertinent Virginia law. We agree that the proper forum for trial of any dispute involving our liability to the Commonwealth of Virginia, Department of Mines, Minerals and Energy, Division of Mined Land Reclamation, on this Letter of Credit shall lie in the Wise County Circuit Court, Wise, Virginia pursuant to our intent hereby to do business in the Commonwealth of Virginia.

Attached hereto is a certified copy of the Corporation's Resolution authorizing the undersigned to execute this Letter of Credit on behalf of \_\_\_\_\_ (name of Bank).

All drafts drawn under this credit shall state that they are, "Drawn under \_\_\_\_\_ Letter of Credit Number \_\_\_\_\_, dated \_\_\_\_\_ for Permit No. \_\_\_\_\_."

We hereby agree that drafts drawn under and in compliance with the terms of the Irrevocable Letter of Credit will be duly honored on due presentation to the Drawee.

By: \_\_\_\_\_

Title: \_\_\_\_\_

---

# GOVERNOR

---

## **EXECUTIVE ORDER NUMBER NINE (98)**

### **CREATING THE OFFICE OF THE SECRETARY OF TECHNOLOGY AND ESTABLISHING A BLUE RIBBON COMMISSION, THE GOVERNOR'S COMMISSION ON INFORMATION TECHNOLOGY**

By virtue of the authority vested in me as Governor under Article V of the Constitution of Virginia, and under the laws of the Commonwealth including but not limited to Section 2.1-51.27 and Section 2.1-51.36 of the Code of Virginia, and subject to my continuing and ultimate authority and responsibility to act in such matters, I hereby create the Cabinet level position of Secretary of Technology and create the Governor's Commission on Information Technology.

#### **Preamble**

Never in history has a single industry brought about more change in less time than has the information technology industry. It is affecting everyone, everywhere, every day, and it complements the growth of other advanced technology industries. Within this context, Virginia is rapidly emerging as a world technology leader. Already home to perhaps the greatest concentration of Internet businesses in the world, as well as a broad and expanding information and advanced technology base, Virginia government needs to ensure that its policies, education infrastructure, and use of technology encourage continued growth of the Commonwealth's technology base. Focused attention to these areas offers the best assurance that all parts of the Commonwealth participate in Virginia's emergence as a world technology center.

With Virginia's technology sector growing at a rate of more than three times the rate of the Commonwealth's overall economy, it is essential that we establish a single point of responsibility and accountability for information technology through the appointment of a Secretary of Technology.

#### **Part 1: Office of the Secretary of Technology**

In order to ensure the coordinated planning and effective development of information technology resources in the Commonwealth, I hereby establish the position of the Secretary of Technology, who shall serve as the Chief Information Officer of the Commonwealth. The Secretary of Technology will report directly to the Governor and hold Cabinet rank.

The Secretary of Technology will be a top official committed to the technology sector who will encourage both the use of efficient technology by state government and appropriate initiatives to ensure a technology-friendly business climate across the Commonwealth. It shall be the responsibility of the Secretary of Technology to:

- Direct and coordinate development of a statewide information infrastructure to facilitate more efficient communication and operation of government and education systems and processes.

- Develop and promote a strategy to train, educate, and support a technology workforce, with particular emphasis on the Commonwealth's college and university system.
- Develop and promote policy recommendations for creating a business environment that encourages the location and expansion of information and advanced technology businesses.
- Develop and promote a business strategy to encourage statewide investment in information and advanced technology businesses, with particular emphasis on regions where employment and economic development require more focused attention.
- Coordinate the activities of the Department of Information Technology (DIT) and the Council on Information Management (CIM).
- Work closely with the Century Date Change Initiative Project Office to ensure the Commonwealth is in compliance with the upcoming date change.
- Work with the Department of General Services to ensure the facilitation of new, business driven procurement solutions.

#### **Part 2: The Governor's Commission on Information Technology**

I hereby create the Governor's Commission on Information Technology. The Commission is classified as a gubernatorial advisory commission in accordance with Sections 2.1-51.35 and 9-6.25 of the Code of Virginia.

The Commission shall advise the Governor on the implementation of a statewide information technology initiative. This initiative shall include critical issues of workforce training and education, business environment, and statewide technology investment strategy.

The specific duties of the Commission shall include the following:

- The Commission shall advise the Governor as to how to establish the most comprehensive long-term policies and planning to ensure cooperation between state government and the information technology industry. Any recommendations involving tax and regulatory policy shall be made to the Governor through the Secretary of Finance.
- The Commission shall advise the Governor on development of the state's information technology infrastructure to facilitate state-of-the-art communications capabilities by and among state and local governments, libraries, and universities.
- The Commission shall assist the Governor's Blue Ribbon Commission on Higher Education in advising the Governor on all matters involving workforce training to ensure that the Commonwealth's colleges and her business community recognize the singular mission of

---

# Governor

---

meeting the workforce needs in the 21st Century to produce a well-educated, well-informed, and involved citizenry.

The Commission shall be composed of no more than 30 members, appointed by the Governor and serving at his pleasure. The Commission shall include a broad representation of business leaders from across the Commonwealth. It shall also include bipartisan representation from the Virginia General Assembly. Membership on the Commission shall consist of the Secretary of Technology, the Secretary of Education, the Secretary of Commerce and Trade, 21 business leaders, and six members of the General Assembly.

The Secretary of Technology shall serve as Chairman of the Commission and shall direct the work of the Commission. The Governor shall appoint a Vice Chairman from the private sector to work directly with the Chairman.

Members of the Commission shall serve without compensation but shall receive reimbursement for expenses incurred in the discharge of their official duties only upon approval by the Secretary of Technology.

Such staff support as is necessary for the Commission's work during the term of its existence shall be furnished by the Office of the Governor, the Offices of the Governor's Secretaries, the Department of Information Technology, the Council on Information Management, and other such executive department agencies as the Governor may designate.

An estimated 5,000 hours of staff time will be required to support the work of the Commission. Funding necessary to support the Commission's work shall be provided from sources, including both private contributions and state funds appropriated for purposes related to the work of the Commission, as authorized by Section 2.1-51.37 of the Code of Virginia. Direct expenditures for the Commission's work are estimated to be \$103,000.

The Commission shall complete its work and issue a final report to the Governor no later than December 1, 1999, unless the Governor shall direct otherwise, subject to issuance of an appropriate continuation order pursuant to Section 2.1-51.37 of the Code of Virginia. The Commission shall issue interim reports and make recommendations at such times as it deems appropriate, or upon the Governor's request.

### **Part 3: Supervision of agencies by the Governor's secretaries**

The Department of Information Technology (DIT) and the Council on Information management (CIM), now reporting to the Secretary of Administration, are hereby reassigned to the Secretary of Technology pursuant to my authority under Section 2.1-51.27 of the Code of Virginia. The Governor will request introduction of legislation to the 1999 session of the General Assembly to codify this action.

Part 3 of this Executive Order amends Executive Order Thirty-One (94), Authority and Responsibility of the

Governor's Secretaries and Other Senior Executive Branch Officials, issued by Governor Allen on October 25, 1994.

This Executive Order amends Executive Order Nineteen (94), Exempting Certain Staff positions from the Personnel Act, issued by Governor Allen on June 30, 1994, to include all positions in the Office of the Secretary of Technology.

This Executive Order shall be effective upon its signing and shall remain in force and effect until June 30, 2001, unless amended or rescinded by further executive order.

Given under my hand and the seal of the Commonwealth of Virginia this 21st day of May, 1998.

/s/ James S. Gilmore, III  
Governor

VA.R. Doc. No. R98-248; Filed May 27, 1998, 10:47 a.m.

---

# SCHEDULES FOR COMPREHENSIVE REVIEW OF REGULATIONS

---

Governor George Allen issued and made effective Executive Order Number Fifteen (94) on June 21, 1994. This Executive Order was published in *The Virginia Register of Regulations* on July 11, 1994 (10:21 VA.R. 5457-5461 July 11, 1994). The Executive Order directs state agencies to conduct a comprehensive review of all existing regulations to be completed by January 1, 1997, and requires a schedule for the review of regulations to be developed by the agency and published in *The Virginia Register of Regulations*. This section of the *Virginia Register* has been reserved for the publication of agencies' review schedules. Agencies will receive public comment on the following regulations listed for review.

## DEPARTMENT OF SOCIAL SERVICES

Pursuant to Executive Order Number Fifteen (94), the Department of Social Services is currently reviewing the below listed regulation to determine if it should be terminated, amended, or retained in its current form. The review will be guided by the principles listed in Executive Order Number Fifteen (94) and in the department's Plan for Review of Existing Agency Regulations.

The department seeks public comment regarding the regulation's interference in private enterprise and life, essential need of the regulation, less burdensome and intrusive alternatives to the regulation, specific and measurable goals that the regulation is intended to achieve, and whether the regulation is clearly written and easily understandable.

The regulation is:

22 VAC 40-890-10 et seq., Human Subject Research Regulations. Contact: Sue Murdock; Management Lead Analyst; Research, Evaluation and Legislation Services Unit; telephone (804) 692-1885 or FAX (804) 692-1808.

Written comments may be submitted until July 22, 1998, in care of the above listed contact at 730 East Broad Street, Richmond, Virginia 23219-1849, or by facsimile to the above listed number.

---

# GENERAL NOTICES/ERRATA

---

## STATE CORPORATION COMMISSION

AT RICHMOND, MAY 27, 1998

COMMONWEALTH OF VIRGINIA

At the relation of the

STATE CORPORATION COMMISSION

CASE NO. PUC980056

Ex Parte: In the matter of  
revising the telephone relay  
service surcharge pursuant to  
Article 5, Chapter 15, Title 56  
of the Code of Virginia

### ORDER

The 1998 Session of the Virginia General Assembly reauthorized the continuation of the Virginia Telecommunications Relay Center to furnish telephone relay service ("TRS"). In the Joint Conference Committee Report on House Bill No. 30, 1998 Session March 17, 1998, at p.48, the General Assembly specifically instructed the Department of Information Technology to require, in developing a request for proposals, that (1) the relay center be located in Norton, Virginia; (2) a minimum employment level of 104 full-time communications assistants be maintained; and (3) the contract be renewable for up to five years. These criteria effectively limit the bidding for the contract to furnish relay service to a single vendor.

By Order of October 5, 1990, in Case No. PUC900029, the Commission established the assessment, collection and disbursement of rate surcharges authorized by § 56-484.6 of the Code of Virginia in order to fund the relay center. Pursuant to that section and the directives of the General Assembly, it is the Commission's duty to assure adequate revenues to fund operation of the relay center in accordance with the conditions described above. The Department of Information Technology and AT&T Communications have reached an agreement that conforms to the General Assembly directives and substantially increases the per-minute charges for AT&T to operate the relay center under the conditions imposed. Based upon those charges, the Commission has determined that the ten cents surcharge established by our order of October 5, 1990, must be increased to sixteen cents in order to produce sufficient revenues to fund the operation of the relay center for the fiscal year commencing July 1, 1998. Accordingly,

IT IS THEREFORE ORDERED THAT:

(1) This matter is hereby docketed and assigned Case No. PUC980056.

(2) Commencing with telephone service rendered on and after September 1, 1998, each Virginia local exchange company ("LEC") shall impose a \$.16 per month surcharge on each access line or equivalent Centrex access line and shall continue such surcharge monthly until further order of the Commission. LECs shall notify their customers of the increased surcharge. LECs shall continue to identify the

surcharge on each customer bill as a line item named "Virginia Relay Center surcharge" or a suitable abbreviation of that phrase.

(3) Each Virginia LEC, on October 1, 1998, and monthly thereafter, shall, pursuant to instructions from the Director of the Division of Public Service Taxation, pay over to the Commission's Division of Public Service Taxation the funds collected from the surcharge, less a 2% commission as authorized by § 56-484.6B of the Code of Virginia.

(4) All Virginia LECs shall continue to comply with the Commission's Order of October 5, 1990, in Case No. PUC900029. In addition, all LECs shall (1) apply a total service uncollectible allowance, and (2) determine Centrex access line equivalents in the manner described in the Staff Report on Telecommunications Relay Services Remittances for the Three Years Ending June 30, 1996, produced by the Division of Public Utility Accounting. All reports or information required by this Order, by that previous order, or as needed by the Commission's Divisions of Public Service Taxation, Public Utility Accounting, Economics and Finance, or Communications concerning the Virginia Relay Center shall be submitted to those divisions.

(5) This matter is continued generally and this docket shall remain open to address any additional matters that may arise concerning funding of the Virginia Relay Center.

AN ATTESTED COPY hereof shall be sent by the Clerk of the Commission to: Virginia's local exchange companies as set out in Appendix A attached hereto; the Virginia Department for the Deaf and Hard of Hearing, Washington Building, 1100 Bank Street, Richmond, Virginia 23219-3460; the Department of Information Technology, P.O. Box 1199, Richmond, Virginia 23209; the Division of Consumer Counsel, Office of the Attorney General, 900 East Main Street, Richmond, Virginia 23219; the Commission's Office of General Counsel; and to the Commission's Divisions of Communications, Public Utility Accounting, Economics and Finance, and Public Service Taxation.

VA.R. Doc. No. C98-1386; Filed June 2, 1998, 11:48 a.m.

## VIRGINIA CODE COMMISSION

### Notice to Subscribers

Beginning with Volume 14, Issue 1 of the Virginia Register (14:1 VA.R. September 29, 1997), the format of the Register changed slightly. Regulations and other information previously published in the State Corporation Commission, Marine Resources Commission, State Lottery Department, and Tax Bulletin sections have been merged into the Proposed Regulations, Final Regulations, Emergency Regulations, or General Notices sections as appropriate. In addition, regulations appear in order by Virginia Administrative Code (VAC) title order to correspond with the VAC.



### Notice to State Agencies

**Mailing Address:** Virginia Code Commission, 910 Capitol Street, General Assembly Building, 2nd Floor, Richmond, VA 23219. You may FAX in your notice; however, we ask that you FAX two copies and do not follow up with a mailed copy. Our FAX number is: (804) 692-0625.

### Forms for Filing Material for Publication in *The Virginia Register of Regulations*

All agencies are required to use the appropriate forms when furnishing material for publication in *The Virginia Register of Regulations*. The forms may be obtained from: Virginia Code Commission, 910 Capitol Street, General Assembly Building, 2nd Floor, Richmond, VA 23219, telephone (804) 786-3591.

**Internet:** Forms and other *Virginia Register* resources may be printed or downloaded from the *Virginia Register* web page:

<http://legis.state.va.us/codecomm/register/regindex.htm>

#### FORMS:

NOTICE of INTENDED REGULATORY ACTION - RR01  
NOTICE of COMMENT PERIOD - RR02  
PROPOSED (Transmittal Sheet) - RR03  
FINAL (Transmittal Sheet) - RR04  
EMERGENCY (Transmittal Sheet) - RR05  
NOTICE of MEETING - RR06  
AGENCY RESPONSE TO LEGISLATIVE OBJECTIONS  
- RR08

---

# CALENDAR OF EVENTS

---

## Symbol Key

† Indicates entries since last publication of the *Virginia Register*

 Location accessible to handicapped

 Telecommunications Device for Deaf (TDD)/Voice Designation

## NOTICE

Only those meetings which are filed with the Registrar of Regulations by the filing deadline noted at the beginning of this publication are listed. Since some meetings are called on short notice, please be aware that this listing of meetings may be incomplete. Also, all meetings are subject to cancellation and the *Virginia Register* deadline may preclude a notice of such cancellation.

For additional information on open meetings and public hearings held by the standing committees of the legislature during the interim, please call Legislative Information at (804) 698-1500 or Senate Information and Constituent Services at (804) 698-7410 or (804) 698-7419/TDD , or visit the General Assembly web site's Legislative Information System (<http://leg1.state.va.us/lis.htm>) and select "Meetings."

VIRGINIA CODE COMMISSION

## EXECUTIVE

### BOARD FOR ACCOUNTANCY

**July 20, 1998 - 10 a.m.** -- Open Meeting

**July 21, 1998 - 8 a.m.** -- Open Meeting

Department of Professional and Occupational Regulation,  
3600 West Broad Street, 5th Floor, Richmond, Virginia.

An open meeting to discuss regulatory review, committee reports, disciplinary cases and other matters requiring board action. Call the board office to confirm date and time of meeting. A public comment period will be held at the beginning of the meeting. Persons desiring to participate in the meeting and requiring special accommodations or interpreter services should contact the department at least 10 days prior to the meeting so that suitable arrangements can be made. The department fully complies with the Americans with Disabilities Act.

**Contact:** Nancy Taylor Feldman, Assistant Director,  
Department of Professional and Occupational Regulation,  
3600 W. Broad St., Richmond, VA 23230-4917, telephone  
(804) 367-8590 or (804) 367-9753/TDD 

### BOARD OF AGRICULTURE AND CONSUMER SERVICES

† **July 21, 1998 - 9 a.m.** -- Open Meeting

Eastern Shore Virginia Chamber of Commerce, U. S. Route  
13, Melfa, Virginia.

A regular meeting to discuss Virginia agriculture and consumer protection. The board will entertain public comment at the conclusion of all other business for a period not to exceed 30 minutes. Any person who needs any accommodation in order to participate at the meeting should contact Roy E. Seward at least five days before the meeting date so that suitable arrangements can be made.

**Contact:** Roy E. Seward, Secretary to the Board,  
Department of Agriculture and Consumer Services, P.O. Box  
1163, Room 211, Richmond, VA 23218, telephone (804)  
786-3538 or FAX (804) 371-7679.

### DEPARTMENT OF AGRICULTURE AND CONSUMER SERVICES

#### Virginia Horse Industry Board

**July 9, 1998 - 11 a.m.** -- Open Meeting

VPI & SU, Donaldson Brown Continuing Education Center  
and Alumni Hall, Conference Room C, Blacksburg,  
Virginia. 

A meeting to review reports on grants previously awarded and discuss updates on recent marketing projects. Budget items will also be reviewed as well as future marketing projects. The board will entertain public comments at the conclusion of all other business for a period not to exceed 30 minutes. Any person who needs any accommodations in order to participate at the meeting should contact Andrea S. Heid at least five days before the meeting date so that suitable arrangements can be made.

**Contact:** Andrea S. Heid, Equine Marketing  
Specialist/Program Manager, Virginia Horse Industry Board,  
1100 Bank St., Suite 1004, Richmond, VA 23219, telephone  
(804) 786-5842 or FAX (804) 371-7786.

#### Virginia Sheep Industry Board

**July 10, 1998 - 3:30 p.m.** -- Open Meeting

Ryan's Steak House, 2580 North Franklin Street,  
Christiansburg, Virginia. 

The board will (i) hear reports on previously funded projects, (ii) make plans for serving lamb at the Virginia Food Festival, (iii) continue plans for a Virginia Sheep Industry Directory, and (iv) consider a policy for

accepting funding requests. The board will entertain public comments at the conclusion of all other business for a period not to exceed 30 minutes. Any person who needs any accommodation in order to participate at the meeting should contact Mike Carpenter at least five days before the meeting date so that suitable arrangements can be made.

**Contact:** Mike Carpenter, Program Director, Livestock Marketing Services, Department of Agriculture and Consumer Services, 116 Reservoir St., Harrisonburg, VA 22801, telephone (540) 434-0779 or FAX (540) 434-5607.

## Virginia Small Grains Board

**July 28, 1998 - 8 a.m.** -- Open Meeting  
Richmond Airport Hilton, 5501 Eubank Road, Sandston, Virginia. 

A meeting to (i) hear FY 1997-98 project reports, (ii) receive FY 1998-99 project proposals, and (iii) allocate funding for FY 1998-99 projects. Additionally, action will be taken on any other new business that comes before the board. The board will entertain public comment at the conclusion of all other business for a period not to exceed 30 minutes. Any person who needs any accommodation in order to participate at the meeting should contact Philip T. Hickman at least five days before the meeting date so that suitable arrangements can be made.

**Contact:** Philip T. Hickman, Program Director, Virginia Small Grains Board, Washington Bldg., 1100 Bank St., Room 1005, Richmond, VA 23219, telephone (804) 371-6157 or FAX (804) 371-7786.

## Virginia Soybean Board

**August 6, 1998 - 2:30 p.m.** -- Open Meeting  
Colonial Acres Farm, 7031 South Laburnum Avenue, Richmond, Virginia. 

A meeting to discuss checkoff revenues and the financial status of the board following the end of the fiscal year ending June 30, 1998. The Virginia 1998 Corn and Soybean Conference financial report will be discussed along with the Ag-Expo plans for the upcoming event, as well as reports from the Chairman of the United Soybean Board representatives, and from other committees. The board will entertain public comment at the conclusion of all other business for a period not to exceed 30 minutes. Any person who needs any accommodation in order to participate at the meeting should contact Phil Hickman at least five days before the meeting date so that suitable arrangements can be made.

**Contact:** Philip T. Hickman, Program Director, Virginia Soybean Board, 1100 Bank St., Suite 1005, Richmond, VA 23219, telephone (804) 371-6157 or FAX (804) 371-7786.

## Virginia Winegrowers Advisory Board

**† July 21, 1998 - 10 a.m.** -- Open Meeting  
State Capitol, Capitol Square, House Room 1, Richmond, Virginia. 

A regular meeting to elect officers for the upcoming year, including a new chairman, and to conduct regular business including discussion of committee reports. The board will entertain public comment at the conclusion of all other business for a period not to exceed 30 minutes. Any person who needs any accommodations in order to participate at the meeting should contact Mary E. Davis-Barton at least five days before the meeting date so that suitable arrangements can be made.

**Contact:** Mary E. Davis-Barton, Secretary, Virginia Winegrowers Advisory Board, Department of Agriculture and Consumer Services, 1100 Bank St., Room 1010, Richmond, VA 23219, telephone (804) 371-7685 or FAX (804) 786-3122.

## ALCOHOLIC BEVERAGE CONTROL BOARD

**June 29, 1998 - 9:30 a.m.** -- Open Meeting  
Department of Alcoholic Beverage Control, 2901 Hermitage Road, Richmond, Virginia. 

A meeting to receive reports from and discuss activities of staff members, and to discuss other matters not yet determined.

**Contact:** W. Curtis Coleburn, Secretary to the Board, Department of Alcoholic Beverage Control, 2901 Hermitage Rd., P.O. Box 27491, Richmond, VA 23261, telephone (804) 213-4409 or FAX (804) 213-4442.

## VIRGINIA BOARD FOR ASBESTOS AND LEAD

**August 25, 1998 - 10 a.m.** -- Open Meeting  
Department of Professional and Occupational Regulation, 3600 West Broad Street, Conference Room 5 West, Richmond, Virginia. 

A meeting to conduct routine business. A public comment period will be held at the beginning of the meeting. Persons desiring to participate in the meeting and requiring special accommodations or interpreter services should contact the board at least 10 days prior to the meeting so that suitable arrangements can be made. The board fully complies with the Americans with Disabilities Act.

**Contact:** David E. Dick, Assistant Director, Department of Professional and Occupational Regulation, 3600 W. Broad St., Richmond, VA 23230-4917, telephone (804) 367-8595, FAX (804) 367-2475, (804) 367-9753/TDD , or e-mail [asbestos@dpor.state.va.us](mailto:asbestos@dpor.state.va.us).

---

# Calendar of Events

---

## COMPREHENSIVE SERVICES FOR AT-RISK YOUTH AND THEIR FAMILIES

### State Management Team

† **July 2, 1998 - 9:30 a.m.** -- Open Meeting  
St. Joseph's Villa, 8000 Brook Road, Board Room,  
Richmond, Virginia.  (Interpreter for the deaf provided upon  
request)

A meeting to discuss recommendations for policies and  
procedures to the State Executive Council on the  
Comprehensive Services Act.

**Contact:** Elisabeth Hutton, Secretary, Department of  
Health, P.O. Box 2448, Richmond, VA 23218, telephone  
(804) 371-4099.

## AUCTIONEERS BOARD

† **July 14, 1998 - 10 a.m.** -- Open Meeting  
Department of Professional and Occupational Regulation,  
3600 West Broad Street, Richmond, Virginia. 

A meeting to conduct general board business. Persons  
desiring to participate in the meeting and requiring  
special accommodations or interpreter services should  
contact the department at least 10 days prior to the  
meeting so that suitable arrangements can be made.  
The department fully complies with the Americans with  
Disabilities Act.

**Contact:** Mark N. Courtney, Assistant Director, Department  
of Professional and Occupational Regulation, 3600 W. Broad  
St., Richmond, VA 23230-4917, telephone (804) 367-8514 or  
(804) 367-9753/TDD 

## BOARD OF AUDIOLOGY AND SPEECH-LANGUAGE PATHOLOGY

† **June 25, 1998 - 9 a.m.** -- Open Meeting  
Department of Health Professions, 6606 West Broad Street,  
5th Floor, Richmond, Virginia. 

A meeting of the Joint Task Force Committee of the  
Board of Audiology and Speech-Language Pathology  
and the Board for Hearing Aid Specialists to discuss the  
drafting of legislation that would combine the two  
boards. Public comment will be heard for 15 minutes  
prior to the beginning of the meeting.

**Contact:** Senita Booker, Senior Program Support  
Technician, Department of Health Professions, 6606 W.  
Broad St., 4th Floor, Richmond, VA 23230-1717, telephone  
(804) 662-7390, FAX (804) 662-9523 or (804) 662-7197/TDD  



## BOARD FOR BRANCH PILOTS

† **July 27, 1998 - 9:30 a.m.** -- Open Meeting  
† **July 30, 1998 - 9:30 a.m.** -- Open Meeting  
Virginia Port Authority, 600 World Trade Center, Norfolk,  
Virginia. 

A meeting to conduct board business. Persons desiring  
to participate in the meeting and requiring special  
accommodations or interpreter services should contact  
the board at least 10 days prior to the meeting so that  
suitable arrangements can be made. The board fully  
complies with the Americans with Disabilities Act.

**Contact:** Mark N. Courtney, Assistant Director, Department  
of Professional and Occupational Regulation, 3600 W. Broad  
St., Richmond, VA 23230-4917, telephone (804) 367-8514 or  
(804) 367-9753/TDD 

## STATE BOARD FOR COMMUNITY COLLEGES

† **July 8, 1998 - Time to be announced** -- Open Meeting  
Virginia Community College System, James Monroe  
Building, 101 North 14th Street, Richmond, Virginia.   
(Interpreter for the deaf provided upon request)

Meetings of board committees will be held throughout  
the day with times and meeting rooms to be announced.

**Contact:** Dr. Joy S. Graham, Assistant Chancellor, Public  
Affairs, Virginia Community College System, James Monroe  
Bldg., 101 N. 14th St., 15th Floor, Richmond, VA 23219,  
telephone (804) 225-2126, FAX (804) 371-0085, or (804)  
371-8504/TDD 

† **July 9, 1998 - 8:30 a.m.** -- Open Meeting  
Virginia Community College System, James Monroe  
Building, 101 North 14th Street, Godwin-Hamel Board  
Room, 15th Floor, Richmond, Virginia.  (Interpreter for the  
deaf provided upon request)

A regular board meeting.

**Contact:** Dr. Joy S. Graham, Assistant Chancellor, Public  
Affairs, Virginia Community College System, James Monroe  
Bldg., 101 N. 14th St., 15th Floor, Richmond, VA 23219,  
telephone (804) 225-2126, FAX (804) 371-0085, or (804)  
371-8504/TDD 

## COMPENSATION BOARD

**June 25, 1998 - 11 a.m.** -- Open Meeting  
Ninth Street Office Building, 202 North Ninth Street, 10th  
Floor Conference Room, Richmond, Virginia.  (Interpreter for  
the deaf provided upon request)

A monthly board meeting.

**Contact:** Cindy Waddell, Administrative Assistant,  
Compensation Board, 202 N. 9th St., 10th Floor, Richmond,  
VA 23219, telephone (804) 786-0786 or FAX (804) 371-  
0235.

## DEPARTMENT OF CONSERVATION AND RECREATION

**July 7, 1998 - Noon** -- Open Meeting  
First Landing/Seashore State Park, Visitor's Center, 2500 Shore Drive, Virginia Beach, Virginia.  (Interpreter for the deaf provided upon request)

A meeting of the State Park Master Plan Team to revise the park master plan.

**Contact:** Derral Jones, Environmental Program Manager, Department of Conservation and Recreation, 203 Governor St., Suite 326, Richmond, VA 23219, telephone (804) 786-9042 or FAX (804) 371-7899.

**July 15, 1998 - 9:30 a.m.** -- Open Meeting

**August 20, 1998 - 9:30 a.m.** -- Open Meeting  
James Monroe Building, 101 North 14th Street, Conference Room B, Richmond, Virginia.

A meeting for development of model ordinance and educational materials regarding wetlands, riparian buffers and environment erosion control structures. Public comments will be received at the end of the meeting.

**Contact:** Leon E. App, Agency Regulatory Coordinator, 203 Governor Street, Suite 302, Richmond, VA 23219, telephone (804) 786-4570 or FAX (804) 786-6141.

**June 30, 1998 - 11 a.m.** -- Open Meeting

Pocahontas State Park, 10301 State Park Road, Chesterfield, Virginia.

A regular business meeting. Public comments will be received at the end of the meeting.

**Contact:** Leon E. App, Agency Regulatory Coordinator, 203 Governor Street, Suite 302, Richmond, VA 23219, telephone (804) 786-4570 or FAX (804) 786-6141.

### Board on Conservation and Development of Public Beaches

**June 29, 1998 - 10 a.m.** -- Open Meeting

Marine Resources Commission, Meeting Room, Newport News, Virginia.  (Interpreter for the deaf provided upon request)

A meeting to (i) discuss proposals from localities requesting matching grant funds; (ii) review projects approved for the 1996-98 biennium; (iii) review the budget for the 1998-00 biennium and; (iv) receive public comments about public beaches or the activities of the board.

**Contact:** Carlton Lee Hill, Staff Advisor, Department of Conservation and Recreation, 203 Governor St., Suite 206, Richmond, VA 23219, telephone (804) 786-3998 or FAX (804) 786-1798.

### Falls of the James Scenic River Advisory Board

**July 9, 1998 - Noon** -- Open Meeting

City Hall, 900 East Broad Street, Planning Commission Conference Room, 5th Floor, Richmond, Virginia.  (Interpreter for the deaf provided upon request)

A meeting to review river issues. A public comment period will follow the business meeting.

**Contact:** Richard G. Gibbons, Environmental Program Manager, Department of Conservation and Recreation, Division of Planning and Recreation Resources, 203 Governor St., Suite 326, Richmond, VA 23219, telephone (804) 786-4132 or FAX (804) 371-7899.

### BOARD FOR CONTRACTORS

**June 24, 1998 - 10 a.m.** -- Open Meeting

Department of Professional and Occupational Regulation, 3600 West Broad Street, Conference Room 4 W, Richmond, Virginia. 

A quarterly meeting of the Tradesman Certification Committee to consider items of interest relating to the tradesmen section of the Board for Contractors.

**Contact:** Jan McMahan, Administrative Assistant, Tradesman Certification Program, Department of Professional and Occupational Regulation, 3600 W. Broad St., Richmond, VA 23230, telephone (804) 367-6166.

### BOARD OF CORRECTIONS

**July 14, 1998 - 9:30 a.m.** -- Open Meeting

**August 11, 1998 - 9:30 a.m.** -- Open Meeting  
Department of Corrections, 6900 Atmore Drive, Board Room, Richmond, Virginia. 

A meeting of the Correctional Services Committee to discuss correctional services matters which may be presented to the board.

**Contact:** Barbara Fellows, Secretary to the Board, Department of Corrections, 6900 Atmore Dr., Richmond, VA 23225, telephone (804) 674-3235 or FAX (804) 674-3130.

**July 15, 1998 - 8:30 a.m.** -- Open Meeting

**August 12, 1998 - 8:30 a.m.** -- Open Meeting  
Department of Corrections, 6900 Atmore Drive, Richmond, Virginia. 

A meeting of the Administration Committee to discuss administrative matters which may be presented to the full board.

**Contact:** Barbara Fellows, Secretary to the Board, Department of Corrections, 6900 Atmore Dr., Richmond, VA 23225, telephone (804) 674-3235 or FAX (804) 674-3130.

---

# Calendar of Events

---

**July 15, 1998 - 10 a.m.** -- Open Meeting

**August 12, 1998 - 10 a.m.** -- Open Meeting  
Department of Corrections, 6900 Atmore Drive, Richmond, Virginia. ☎

A meeting of the full board to discuss matters which may be presented.

**Contact:** Barbara Fellows, Secretary to the Board, Department of Corrections, 6900 Atmore Dr., Richmond, VA 23225, telephone (804) 674-3235 or FAX (804) 674-3130.

## BOARD FOR COSMETOLOGY

† **July 13, 1998 - 9 a.m.** -- Open Meeting

Department of Professional and Occupational Regulation, 3600 West Broad Street, Conference Room 5 West, Richmond, Virginia. ☎

The board and invited subject matter experts will meet to conduct an exam workshop. A public comment period will be held at the beginning of the workshop. After the public comment period, the workshop will be conducted in closed executive session under the authority of § 2.1-344 A 11 of the Code of Virginia due to the confidential nature of the examination. The public will not be admitted to the closed executive session.

**Contact:** Sharon M. Sweet, Examination Director, Department of Professional and Occupational Regulation, 3600 W. Broad St., Richmond, VA 23230-4917, telephone (804) 367-8572 or (804) 367-9753/TDD ☎

## BOARD OF DENTISTRY

**July 10, 1998 - 9 a.m.** -- Open Meeting

**July 17, 1998 - 9 a.m.** -- Open Meeting

**July 24, 1998 - 9 a.m.** -- Open Meeting

Department of Health Professions, 6606 West Broad Street, 5th Floor, Richmond, Virginia. ☎ (Interpreter for the deaf provided upon request)

The Special Conference Committee will meet to hear disciplinary cases. This is a public meeting; however, no public comment will be taken.

**Contact:** Marcia J. Miller, Executive Director, Board of Dentistry, 6606 W. Broad St., 4th Floor, Richmond, VA 23230-1717, telephone (804) 662-9906 or (804) 662-7197/TDD ☎

**July 10, 1998 - 9 a.m.** -- Open Meeting

Department of Health Professions, 6606 West Broad Street, 5th Floor, Richmond, Virginia. ☎ (Interpreter for the deaf provided upon request)

The Legislative/Regulatory Committee will meet to discuss proposing emergency regulations pursuant to § 54.1-2712.1, restricted volunteer license for certain dentists and § 54.1-2726.1, restricted volunteer license for certain dental hygienists. Public comment will be received at the beginning of the meeting.

**Contact:** Marcia J. Miller, Executive Director, Board of Dentistry, 6606 W. Broad St., 4th Floor, Richmond, VA 23230-1717, telephone (804) 662-9906 or (804) 662-7197/TDD ☎

† **July 10, 1998 - 9:30 a.m.** -- Open Meeting

Department of Health Professions, 6606 West Broad Street, 5th Floor, Richmond, Virginia. ☎ (Interpreter for the deaf provided upon request)

A panel of the board will conduct formal hearings to hear disciplinary cases. This is a public meeting; however, no public comment will be taken.

**Contact:** Marcia J. Miller, Executive Director, Board of Dentistry, 6606 W. Broad St., 4th Floor, Richmond, VA 23230-1717, telephone (804) 662-9906 or (804) 662-7197/TDD ☎

## DISABILITY SERVICES COUNCIL

**July 29, 1998 - 11 a.m.** -- Open Meeting

Department of Rehabilitative Services, 8004 Franklin Farms Drive, Richmond, Virginia. (Interpreter for the deaf will be provided)

A meeting to review the FY 1999 Rehabilitative Services Incentive Fund (RSIF) Competitive Proposals for approval.

**Contact:** LaDonna Rogers, Administrative Staff Assistant, Disability Services Council, 8004 Franklin Farms Dr., Richmond, VA 23288, telephone (804) 662-7154/Voice/TTY, toll-free 1-800-552-5019 or 1-800-464-9950/TDD ☎

## DEPARTMENT OF ENVIRONMENTAL QUALITY

### Virginia Ground Water Protection Steering Committee

**July 21, 1998 - 9 a.m.** -- Open Meeting

Department of Environmental Quality, 629 East Main Street, First Floor, Training Room, Richmond, Virginia. ☎

A regularly scheduled meeting. Anyone interested in ground water protection issues is encouraged to attend. To obtain a meeting agenda contact Mary Ann Massie at (804) 698-4042.

**Contact:** Mary Ann Massie, Environmental Program Planner, Department of Environmental Quality, P. O. Box 10009, Richmond, VA 23240-0009, telephone (804) 698-4042 or FAX (804) 698-4032.

## DEPARTMENT OF FORESTRY

### Reforestation of Timberlands Board

**June 24, 1998 - 10 a.m.** -- Open Meeting  
Department of Forestry, Fontaine Research Park, 900  
Natural Resources Drive, Charlottesville, Virginia.   
(Interpreter for the deaf provided upon request)

A meeting to review preliminary information addressing  
the study of the Reforestation of Timberlands Program.

**Contact:** Phil T. Grimm, Staff Forester, Department of  
Forestry, P.O. Box 3758, Charlottesville, VA 22903,  
telephone (804) 977-6555 or FAX (804) 296-2369.

### BOARD OF FUNERAL DIRECTORS AND EMBALMERS

**June 29, 1998 - 9 a.m.** -- Open Meeting  
The Hotel Roanoke and Conference Center, Roanoke,  
Virginia. 

A meeting to conduct a formal hearing. Public  
comments will not be received.

**Contact:** Cheri Emma-Leigh, Administrative Staff Assistant,  
Board of Funeral Directors and Embalmers, 6606 W. Broad  
St., 4th Floor, Richmond, VA 23230-1717, telephone (804)  
662-9907 or FAX (804) 662-9523.

**July 1, 1998 - 1 p.m.** -- Open Meeting  
The Hotel Roanoke and Conference Center, Roanoke,  
Virginia. 

A general board meeting. Public comments will be  
received for 15 minutes at the beginning of the meeting.

**Contact:** Cheri Emma-Leigh, Administrative Staff Assistant,  
Board of Funeral Directors and Embalmers, 6606 W. Broad  
St., 4th Floor, Richmond, VA 23230-1717, telephone (804)  
662-9907 or FAX (804) 662-9523.

† **August 12, 1998 - 9 a.m.** -- Open Meeting  
Department of Health Professions, 6606 West Broad Street,  
4th Floor, Richmond, Virginia. 

A meeting of the Regulatory and Bylaws Committee to  
discuss crematory regulations. Public comments will be  
received for 15 minutes at the beginning of the meeting.

**Contact:** Cheri Emma-Leigh, Administrative Staff Assistant,  
Board of Funeral Directors and Embalmers, 6606 W. Broad  
St., 4th Floor, Richmond, VA 23230-1717, telephone (804)  
662-9907 or FAX (804) 662-9523.

## DEPARTMENT OF GAME AND INLAND FISHERIES

† **June 29, 1998 - 7 p.m.** -- Public Hearing  
Department of Game and Inland Fisheries, 4000 West Broad  
Street, Richmond, Virginia.  (Interpreter for the deaf  
provided upon request)

A public hearing to receive comments regarding: (i) a  
DGIF regulation amendment proposed by the Board of  
Game and Inland Fisheries at its April 2, 1998, meeting  
which would allow any nontoxic shot approved by the  
U.S. Fish and Wildlife Service for use in waterfowl  
hunting to be approved for such use in Virginia by the  
Director of the Department of Game and Inland  
Fisheries and (ii) season lengths and bag limits for the  
1998-1999 hunting seasons for webless migratory game  
birds (dove, rails, snipe, and woodcock) and for  
September Canada goose season. Wildlife Division  
staff will present frameworks provided by the U.S. Fish  
and Wildlife Service for these species. The public's  
comments will be solicited in the public hearing portion  
of the meeting.

A summary of the results of this public hearing will be  
presented to the Board of Game and Inland Fisheries at  
its scheduled July 16-17, 1998, meeting. At the July 16-  
17 meeting the board will hold another public hearing,  
after which it intends to adopt final regulation  
amendments and 1998-1999 hunting seasons and bag  
limits for webless migratory game birds and the  
September Canada goose season.

For more information, call the Virginia Department of  
Game and Inland Fisheries at (804) 367-1000.

**Contact:** Phil Smith, Policy Analyst, Department of Game  
and Inland Fisheries, 4010 West Broad St., Richmond, VA  
23230, telephone (804) 367-8341 or FAX (804) 367-2311.

## DEPARTMENT OF GENERAL SERVICES

### Design-Build/Construction Management Review Board

**July 20, 1998 - 11 a.m.** -- Open Meeting  
**August 17, 1998 - 11 a.m.** -- Open Meeting  
The Library of Virginia, 800 East Broad Street, Richmond,  
Virginia.  (Interpreter for the deaf provided upon request)

A meeting to review requests submitted by localities for  
the use of the design-build or construction management  
type of contract. Public comments will be taken. The  
chairman may cancel the meeting if there is not  
business for the board's consideration. Please contact  
the Division of Engineering and Buildings to confirm  
meeting date and time.

**Contact:** Sandra H. Williams, Board Clerk, Division of  
Engineering and Buildings, Department of General Services,  
805 E. Broad St., Room 101, Richmond, VA 23219,  
telephone (804) 786-3263 or (804) 786-6152/TDD 

---

# Calendar of Events

---

## DEPARTMENT OF HEALTH

### Biosolids Use Information Committee

† **July 9, 1998 - 1 p.m.** -- Open Meeting  
UVA Richmond Center, 7740 Shrader Road, Suite E,  
Richmond, Virginia. 

A meeting immediately following the 10 a.m. Regulations Advisory Committee meeting to evaluate specific concerns relating to the land application and agricultural use of biosolids, including the final Biosolids Use Regulations and the land application, marketing or distribution of biosolids.

**Contact:** C. M. Sawyer, Director, Division of Wastewater Engineering, Department of Health, Office of Water Programs, P.O. Box 2448, Richmond, VA 23218, telephone (804) 786-1755 or FAX (804) 371-2891.

### Biosolids Use Regulations Advisory Committee

† **July 9, 1998 - 10 a.m.** -- Open Meeting  
UVA Richmond Center, 7740 Shrader Road, Suite E,  
Richmond, Virginia. 

A meeting to discuss issues concerning the implementation of the Biosolids Use Regulations involving land application, distribution or marketing of biosolids.

**Contact:** C. M. Sawyer, Director, Division of Wastewater Engineering, Department of Health, Office of Water Programs, P.O. Box 2448, Richmond, VA 23218, telephone (804) 786-1755 or FAX (804) 371-2891.

### BOARD FOR HEARING AID SPECIALISTS

**June 25, 1998 - 9 a.m.** -- Open Meeting  
Department of Health Professions, 6606 West Broad Street,  
5th Floor, Conference Room 3, Richmond, Virginia. 

Representatives from the Board for Hearing Aid Specialists shall meet with representatives from the Board of Audiology and Speech-Language Pathology. A public comment period will be held at the beginning of the meeting. Persons desiring to participate in the meeting and requiring special accommodations or interpreter services should contact the department at least 10 days prior to the meeting so that suitable arrangements can be made. The department fully complies with the Americans with Disabilities Act.

**Contact:** David E. Dick, Assistant Director, Department of Professional and Occupational Regulation, 3600 W. Broad St., Richmond, VA 23230, telephone (804) 367-8595, FAX (804) 367-2475 or (804) 367-9753/TDD , e-mail hearingaidspec@dpor.state.va.us.

## VIRGINIA HISTORIC PRESERVATION FOUNDATION

**June 22, 1998 - 10 a.m.** -- Open Meeting  
Department of Historic Resources, 2801 Kensington Avenue,  
2nd Floor, Conference Room, Richmond, Virginia.   
(Interpreter for the deaf provided upon request)

A meeting of the trustees of the foundation to consider proposals to preserve significant threatened historic properties through acquisition and resale with appropriate protective covenants.

**Contact:** Robert A. Carter, Director, Community Services, Department of Historic Resources, 10 Courthouse Ave., Petersburg, VA 23803, telephone (804) 863-1626, FAX (804) 863-1627 or (804) 367-2386/TDD 

## HOPEWELL INDUSTRIAL SAFETY COUNCIL

**July 7, 1998 - 9 a.m.** -- Open Meeting  
Hopewell Community Center, Second and City Point Road,  
Hopewell, Virginia.   
(Interpreter for the deaf provided upon request)

Local Emergency Preparedness Committee meeting on emergency preparedness as required by SARA Title III.

**Contact:** Robert Brown, Emergency Services Coordinator, 300 N. Main St., Hopewell, VA 23860, telephone (804) 541-2298.

## STATEWIDE INDEPENDENT LIVING COUNCIL

**June 23, 1998 - 10 a.m.** -- Open Meeting  
Department of Rehabilitative Services, 8004 Franklin Farms  
Drive, Richmond, Virginia.   
(Interpreter for the deaf provided upon request)

A special planning meeting to finalize the State Plan for Independent Living for Virginia.

**Contact:** Jim Rothrock, Statewide Independent Living Council Staff, 1802 Marroit Rd., Richmond, VA 23229, telephone (804) 673-0119, FAX (804) 282-7112, or e-mail jarothrock@aol.com.

## DEPARTMENT OF LABOR AND INDUSTRY

### Apprenticeship Council

† **August 5, 1998 - 9:30 a.m.** -- Open Meeting  
Department of Labor and Industry, Powers-Taylor Building,  
13th South 13th Street, Richmond, Virginia.   
(Interpreter for the deaf provided upon request)

A regular meeting of the subcommittee of the council.

**Contact:** Bev Donati, Assistant Program Director, Apprenticeship Program, Department of Labor and Industry,



Powers-Taylor Bldg., 13 S. 13th St., Richmond, VA 23219, telephone (804) 786-2382, FAX (804) 786-8418, or (804) 786-2376/TDD ☎

## STATE LAND EVALUATION ADVISORY COUNCIL

**August 11, 1998 - 10 a.m.** -- Open Meeting

Virginia Department of Taxation, 2220 West Broad Street, Richmond, Virginia. ♿

A meeting to adopt suggested ranges of values for agricultural, horticultural, forest and open-space land use and the use-value assessment program.

**Contact:** H. Keith Mawyer, Property Tax Manager, Department of Taxation, Office of customer Services, Property Tax Unit, 2220 W. Broad St., Richmond, VA 23220, telephone (804) 367-8020.

## COMMISSION ON LOCAL GOVERNMENT

**July 20, 1998 - 10 a.m.** -- Open Meeting

Commission on Local Government, Eighth Street Office Building, 805 East Broad Street, Room 702, Richmond, Virginia. ♿ (Interpreter for the deaf provided upon request)

A regular meeting to consider such matters as may be presented. Persons desiring to participate in the meeting and requiring special accommodations or interpreter services should contact the commission.

**Contact:** Barbara Bingham, Administrative Assistant, Commission on Local Government, Eighth Street Office Bldg., 805 E. Broad St., Room 702, Richmond, VA 23219-1924, telephone (804) 786-6508, FAX (804) 371-7999 or (804) 786-1860/TDD ☎

## VIRGINIA MANUFACTURED HOUSING BOARD

**July 28, 1998 - 1 p.m.** -- Open Meeting

Ramada Plaza Resort Hotel, Oceanfront at 57th Street, Virginia Beach, Virginia. ♿ (Interpreter for the deaf provided upon request)

A regular monthly meeting held in conjunction with the Virginia Manufactured Housing Association's Annual Conference.

**Contact:** Curtis L. McIver, Associate Director, Department of Housing and Community Development, Manufactured Housing Office, The Jackson Center, 501 N. 2nd St., Richmond, VA 23219, telephone (804) 371-7160 or (804) 371-7089/TDD ☎

## MARINE RESOURCES COMMISSION

**June 30, 1998 - 9 a.m.** -- Open Meeting

† **July 28, 1998 - 9 a.m.** -- Open Meeting

† **August 25, 1998 - 9 a.m.** -- Open Meeting

† **September 22, 1998 - 9 a.m.** -- Open Meeting

Marine Resources Commission, 2600 Washington Avenue, Room 403, Newport News, Virginia. ♿ (Interpreter for the deaf provided upon request)

The commission will hear and decide the following marine environmental matters at 9 a.m.: permit applications for projects in wetlands, bottom lands, coastal primary sand dunes and beaches; appeals of local wetland board decisions; policy and regulatory issues. The commission will hear and decide the following fishery management items at approximately noon: regulatory proposals, fishery management plans; fishery conservation issues; licensing; shellfish leasing. Meetings are open to the public. Testimony will be taken under oath from parties addressing agenda items on permits and licensing. Public comments will be taken on resource matters, regulatory issues and items scheduled for public hearing. The commission is empowered to promulgate regulations in the areas of marine environmental management and marine fishery management.

**Contact:** LaVerne Lewis, Secretary to the Commission, Marine Resources Commission, P.O. Box 756, Newport News, VA 23607-0756, telephone (757) 247-2261, toll-free 1-800-541-4646 or (757) 247-2292/TDD ☎

## DEPARTMENT OF MEDICAL ASSISTANCE SERVICES

**June 26, 1998** - Public comments may be submitted until this date.

Notice is hereby given in accordance with § 9-6.14:7.1 of the Code of Virginia that the Department of Medical Assistance Services intends to adopt regulations entitled: **12 VAC 30-100-10 et seq. Health Insurance Program for Working Uninsured Individuals.** These regulations establish the Health Insurance Program for Working Uninsured Individuals. The regulations define, in a fair and equitable manner, who is eligible to receive premium subsidies, how beneficiaries will be enrolled and disenrolled, and what appeal rights they have. The regulations outline the rights and responsibilities of the providers and describe how the Department of Medical Assistance Services monitors the services provided by the managed care plans. The regulations also outline the administrative structure and reimbursement methodology and provide information on the benefit package or covered services.

Statutory Authority: § 32.1-325 of the Code of Virginia.

Public comments may be submitted until June 26, 1998, to John Kenyon, Department of Medical Assistance Services, 600 East Broad Street, Suite 1300, Richmond, VA 23219.

**Contact:** Victoria Simmons or Roberta Jonas, Regulatory Coordinators, Department of Medical Assistance Services, 600 E. Broad St., Suite 1300, Richmond, VA 23219, telephone (804) 371-8854 or FAX (804) 371-4981.

---

# Calendar of Events

---

## BOARD OF MEDICINE

### Informal Conference Committee

**June 24, 1998 - 9:30 a.m.** -- Open Meeting  
Sheraton Inn, 2801 Plank Road, Fredericksburg, Virginia.

**June 26, 1998 - 9:30 a.m.** -- Open Meeting  
† **July 24, 1998 - 9 a.m.** -- Open Meeting  
Williamsburg Marriott, 50 Kingsmill Road, Williamsburg, Virginia.

**July 2, 1998 - 10:30 a.m.** -- Open Meeting  
† **September 3, 1998 - 10:30 a.m.** -- Open Meeting  
Roanoke Airport Marriott, 2801 Hershberger Road, Roanoke, Virginia.

**August 6, 1998 - 10:30 a.m.** -- Open Meeting  
Patrick Henry Hotel, 617 South Jefferson Street, Roanoke, Virginia.

A meeting to inquire into allegations that certain practitioners may have violated laws and regulations governing the practice of medicine and other healing arts in Virginia. The committee will meet in open and closed sessions pursuant to § 2.1-344 A 7 and A 15 of the Code of Virginia. Public comment will not be received.

**Contact:** Karen W. Perrine, Deputy Executive Director, Board of Medicine, 6606 W. Broad St., 4th Floor, Richmond, VA 23230-1717, telephone (804) 662-7332, FAX (804) 662-9517 or (804) 662-7197/TDD ☎

## VIRGINIA MILITARY INSTITUTE

### Board of Visitors

† **August 29, 1998 - 8:30 a.m.** -- Open Meeting  
Virginia Military Institute, Preston Library, Turman Room, Lexington, Virginia. ♿

A meeting to elect a president, vice presidents and secretary, and to hear committee reports. The Board of Visitors will provide an opportunity for public comment immediately after the superintendent's comments, beginning at approximately 9 a.m.

**Contact:** Colonel Edwin L. Dooley, Jr., Secretary to the Board, Virginia Military Institute, Superintendent's Office, Lexington, VA 24450, telephone (540) 464-7206 or (540) 464-7660/TDD ☎

## MOTOR VEHICLE DEALER BOARD

**June 23, 1998 - 10 a.m.** -- Public Hearing  
Northern Virginia Community College, Manassas Campus, 6901 Sudley Road, Colgan Hall, Room MC226, Manassas, Virginia.

**June 27, 1998** - Public comments may be submitted until this date.

Notice is hereby given in accordance with § 9-6.14:7.1 of the Code of Virginia that the Motor Vehicle Dealer Board intends to amend regulations entitled: **24 VAC 22-30-10 et seq. Motor Vehicle Dealer Advertising Practices and Enforcement Regulations.** The purpose of the proposed amendments is to expand the definition of advertisement to include all types of media, including electronic media, and clarify the definition of the terms "free" and "dealer rebates" when used in advertisements.

Statutory Authority: §§ 46.2-1506 and 46.2-1582 of the Code of Virginia.

**Contact:** Bruce Gould, Executive Director, Motor Vehicle Dealer Board, 2201 W. Broad St., Suite 104, Richmond, VA 23220, telephone (804) 367-1100, FAX (804) 367-1053 or toll-free 1-800-272-9268/TDD ☎

## DEPARTMENT OF MOTOR VEHICLES

**July 8, 1998 - 1 p.m.** -- Open Meeting  
Department of Motor Vehicles, 2300 West Broad Street, Richmond, Virginia. ♿

A regular business meeting of the Medical Advisory Board.

**Contact:** Phyllis A. Dardenne, Management Analyst, Department of Motor Vehicles, 2300 W. Broad St., Richmond, VA 23220, telephone (804) 367-2581.

## COMMONWEALTH NEUROTRAUMA INITIATIVE ADVISORY BOARD

**July 23, 1998 - 9:30 a.m.** -- Open Meeting  
Department of Rehabilitative Services, 8004 Franklin Farms Drive, Richmond, Virginia. ♿ (Interpreter for the deaf provided upon request)

A quarterly board meeting.

**Contact:** Charlotte Neal, Board Administrator, Department of Rehabilitative Services, 8004 Franklin Farms Dr., Richmond, VA 23288-0300, telephone (804) 662-7082, toll-free 1-800-552-5019 or 1-800-464-9950/TDD ☎

## BOARD OF NURSING

**June 22, 1998 - 9 a.m.** -- Open Meeting  
**June 23, 1998 - 9 a.m.** -- Open Meeting  
Department of Health Professions, 6606 West Broad Street, 5th Floor, Richmond, Virginia. ♿ (Interpreter for the deaf provided upon request)

A Special Conference Committee, comprised of two or three members of the Board of Nursing, will conduct informal conferences with licensees and certificate holders. Public comment will not be received.

**Contact:** Nancy K. Durrett, R.N., Executive Director, Board of Nursing, 6606 W. Broad St., 4th Floor, Richmond, VA 23230-1717, telephone (804) 662-9909, FAX (804) 662-9943 or (804) 662-7197/TDD ☎

## BOARD OF NURSING HOME ADMINISTRATORS

**July 8, 1998 - 9:30 a.m.** -- Open Meeting  
Department of Health Professions, 6606 West Broad Street, 5th Floor, Richmond, Virginia. ♿

A regular meeting. Public comments will be received for 15 minutes prior to the meeting. A formal hearing will be held following the meeting. No public comments will be heard at that time.

**Contact:** Senita Booker, Administrative Staff Assistant, Board of Nursing Home Administrators, 6606 W. Broad St., 4th Floor, Richmond, VA 23230-1717, telephone (804) 662-9111, FAX (804) 662-9523 or (804) 662-7197/TDD ☎

## VIRGINIA OUTDOORS FOUNDATION

**† June 30, 1998 - 10 a.m.** -- Open Meeting  
State Capitol, Capitol Square, Richmond, Virginia.

A regularly scheduled meeting of the Board of Trustees to discuss foundation business and accept conservation easements. Public input will be accepted after the regular business meeting.

**Contact:** Tamara Vance, Executive Director, Virginia Outdoors Foundation, 203 Governor St., Room 317, Richmond, VA 23219, telephone (804) 225-2147 or FAX (804) 371-4810.

## BOARD OF PHARMACY

**† July 14, 1998 - 9 a.m.** -- Open Meeting  
Department of Health Professions, 6606 West Broad Street, 5th Floor, Conference Room 3, Richmond, Virginia. ♿

A special conference committee to hear informal conferences. Public comments will not be received.

**Contact:** Elizabeth Scott Russell, Executive Director, Board of Pharmacy, 6606 W. Broad St., 4th Floor, Richmond, VA 23230, telephone (804) 662-9911 or FAX (804) 662-9313.

## DEPARTMENT OF STATE POLICE

**August 21, 1998** – Public comments may be submitted through this date.

Notice is hereby given in accordance with § 9-6.14:7.1 of the Code of Virginia that the Department of State Police intends to amend regulations entitled: **19 VAC 30-70-1 et seq. Motor Vehicle Safety Inspection Rules and Regulations.** The purpose of the proposed action is to amend existing administrative regulations

governing vehicle inspections to comply with mandates of the amended sections of the Code of Federal Regulations and the Code of Virginia.

Statutory Authority: § 46.2-1165 of the Code of Virginia.

**Contact:** Captain W. Steven Flaherty, Safety Officer, Department of State Police, P.O. Box 27472, Richmond, VA 23261, telephone (804) 378-3479, FAX (804) 378-3487 or toll-free 1-800-553-3144.

## BOARD OF LICENSED PROFESSIONAL COUNSELORS, MARRIAGE AND FAMILY THERAPISTS AND SUBSTANCE ABUSE TREATMENT PROFESSIONALS

**† June 24, 1998 - 9 a.m.** -- Open Meeting  
Department of Health Professions, 6606 West Broad Street, Conference Room 2, Richmond, Virginia. ♿

Formal administrative hearings will be held pursuant to § 9-6.14:12 of the Code of Virginia. Public comment will not be received.

**Contact:** Evelyn Brown, Executive Director, Board of Licensed Professional Counselors, Marriage and Family Therapists and Substance Abuse Treatment Professionals, 6606 W. Broad St., 4th Floor, Richmond, VA 23230, telephone (804) 662-9967 or FAX (804) 662-9943.

**† June 25, 1998 - 9 a.m.** -- Open Meeting  
Department of Health Professions, 6606 West Broad Street, Conference Room 2, Richmond, Virginia. ♿

The Regulatory Committee of the board will meet to (i) consider requirements for licensure of substance abuse treatment practitioners and (ii) discuss a work plan for review of regulations for substance abuse counselor certification. Public comment will be received at the beginning of the meeting.

**Contact:** Janet Delorme, Deputy Executive Director, Board of Licensed Professional Counselors, Marriage and Family Therapists and Substance Abuse Treatment Professionals, 6606 W. Broad St., 4th Floor, Richmond, VA 23230, telephone (804) 662-9575, FAX (804) 662-9943 or (804) 662-7197/TDD ☎

## VIRGINIA PUBLIC SCHOOL AUTHORITY

**June 29, 1998 - 9:30 a.m.** -- Open Meeting  
James Monroe Building, 101 North 14th Street, 3rd Floor, Richmond, Virginia. ♿

A meeting to consider certain board administrative matters including election of officers, contract review, and other business as necessary.

**Contact:** Richard A. Davis, Debt Manager, Department of the Treasury, Monroe Bldg., 101 N. 14th St., Richmond, VA

---

# Calendar of Events

---

23219, telephone (804) 225-4928 or e-mail richard.davis@trs.state.va.us.

## VIRGINIA RACING COMMISSION

**July 15, 1998 - 9:30 a.m.** -- Open Meeting  
Colonial Downs, Administrative Building, 12007 Courthouse Circle, New Kent, Virginia. 

A regular monthly meeting including a report from Colonial Downs regarding preparations for the full thoroughbred race meeting and a public participation segment.

**Contact:** William H. Anderson, Policy Analyst, Virginia Racing Commission, 10700 Horsemen's Rd., New Kent, VA 23124, telephone (804) 966-4200 or FAX (804) 966-8906.

## REAL ESTATE APPRAISER BOARD

† **July 21, 1998 - 10 a.m.** -- Open Meeting  
Department of Professional and Occupational Regulation, 3600 West Broad Street, Richmond, Virginia. 

A general business meeting. Persons desiring to participate in the meeting and requiring special accommodations or interpreter services should contact the board at least 10 days prior to the meeting. The department fully complies with the Americans with Disabilities Act.

**Contact:** Karen W. O'Neal, Assistant Director, Department of Professional and Occupational Regulation, 3600 W. Broad St., Richmond, VA 23230, telephone (804) 367-0500, FAX (804) 367-2475, or (804) 367-9753/TDD 

## REAL ESTATE BOARD

**June 25, 1998 - 8 a.m.** -- Open Meeting  
Department of Professional and Occupational Regulation, 3600 West Broad Street, Richmond, Virginia. 

General business meetings of the Education Committee and the Fair Housing Committee. Persons desiring to participate in the meetings and requiring special accommodations or interpreter services should contact the board at least two weeks prior to the meetings. The department fully complies with the Americans with Disabilities Act.

**Contact:** Karen W. O'Neal, Assistant Director, Department of Professional and Occupational Regulation, 3600 W. Broad St., Richmond, VA 23230, telephone (804) 367-8526, FAX (804) 367-2475, or (804) 367-9753/TDD 

**June 25, 1998 - 9 a.m.** -- Open Meeting  
Department of Professional and Occupational Regulation, 3600 West Broad Street, Richmond, Virginia. 

A general business meeting. Persons desiring to participate in the meeting and requiring special accommodations or interpreter services should contact

the board at least two weeks prior to the meeting. The department fully complies with the Americans with Disabilities Act.

**Contact:** Karen W. O'Neal, Assistant Director, Department of Professional and Occupational Regulation, 3600 W. Broad St., Richmond, VA 23230, telephone (804) 367-8526, FAX (804) 367-2475, or (804) 367-9753/TDD 

## Common Interest Community Management Information Fund Advisory Committee

**June 24, 1998 - 3 p.m.** -- Open Meeting  
Department of Professional and Occupational Regulation, 3600 West Broad Street, Richmond. 

A meeting to develop a recommendation for the Real Estate Board on uses of moneys collected pursuant to the Common Interest Community Management Fund for the benefit of common interest communities and their members.

**Contact:** Emily O. Wingfield, Property Registration Administrator, Department of Professional and Occupational Regulation, 3600 W. Broad St., Richmond, VA 23230, telephone (804) 367-8510 or (804) 367-9753/TDD 

## VIRGINIA RESOURCES AUTHORITY

**July 14, 1998 - 9:30 a.m.** -- Open Meeting  
Virginia Resources Authority, Mutual Building, 909 East Main Street, Suite 700, Richmond, Virginia.

A meeting to approve minutes of the prior meeting, to review the authority's operations for the prior month, and to consider other matters and take other actions as the authority may deem appropriate. The planned agenda of the meeting will be available at the offices of the authority one week prior to the date of the meeting. Public comments will be received at the beginning of the meeting.

**Contact:** Shockley D. Gardner, Jr., Executive Director, Virginia Resources Authority, P.O. Box 1300, Richmond, VA 23218, telephone (804) 644-3100 or FAX (804) 644-3109.

## VIRGINIA RETIREMENT SYSTEM

**August 20, 1998 - 9 a.m.** -- Open Meeting  
Virginia Retirement System, 1200 East Main Street, Richmond, Virginia. 

A regular meeting. No public comment will be received.

**Contact:** Darla Kestner, Administrative Staff Assistant, Virginia Retirement System, P.O. Box 2500, Richmond, VA 23218-2500, telephone (804) 649-8059, FAX (804) 371-0613, toll-free 1-888-827-3847, or (804) 649-5089/ 

**September 10, 1998 - Noon** -- Open Meeting  
Virginia Retirement System, 1200 East Main Street, Richmond, Virginia. 

A regular meeting of the Investment Advisory Committee. There may be in attendance at any time during the meeting three or more members of the Board of Trustees, or any of their subcommittees. No public comment will be received.

**Contact:** Darla Kestner, Administrative Staff Assistant, Virginia Retirement System, P.O. Box 2500, Richmond, VA 23218-2500, telephone (804) 649-8059, FAX (804) 371-0613, toll-free 1-888-827-3847, or (804) 649-5089/☎

## RICHMOND HOSPITAL AUTHORITY

### Board of Commissioners

† **June 25, 1998 - 5 p.m.** -- Open Meeting  
Richmond Nursing Home, 1900 Cool Lane, 2nd Floor Classroom, Richmond, Virginia. ♿

A monthly board meeting to discuss nursing home operations and related matters.

**Contact:** Marilyn H. West, Chairman, Richmond Hospital Authority, P.O. Box 548, 700 E. Main St., Suite 904, Richmond, VA 23219-0548, telephone (804) 782-1938.

## SCIENCE MUSEUM OF VIRGINIA

† **June 25, 1998 - 3 p.m.** -- Open Meeting  
4009 Fitzhugh Avenue, 1st Floor Conference Room, Richmond, Virginia. ♿ (Interpreter for the deaf provided upon request)

A quarterly meeting.

**Contact:** Karen Spencer, Administrative Assistant, Science Museum of Virginia, 2500 W. Broad St., Richmond, VA 23220, telephone (804) 367-6799, FAX (804) 367-9348, toll-free 1-800-659-1727 or (804) 367-6552/TDD ☎

## VIRGINIA SMALL BUSINESS FINANCING AUTHORITY

### Loan Committee

**June 23, 1998 - 10 a.m.** -- Open Meeting  
Department of Business Assistance, 707 East Main Street, 3rd Floor, Main Board Room, Richmond, Virginia.

A meeting to review applications for loans submitted to the authority for approval. The time is subject to being moved to 8:30 a.m. in the event the VSBFA Board of Directors decides to combine meeting dates with the VSBFA Loan Committee.

**Contact:** Cathleen M. Surface, Executive Director, Virginia Small Business Financing Authority, 707 E. Main St., 3rd Floor, Richmond, VA 23219, telephone (804) 371-8254 or FAX (804) 225-3384.

## STATE BOARD OF SOCIAL SERVICES

**August 7, 1998** - Public comments may be submitted until this date.

Notice is hereby given in accordance with § 9-6.14:7.1 of the Code of Virginia that the State Board of Social Services intends to amend regulations entitled: **22 VAC 40-35-5 et seq. Virginia Independence Program**. The purpose of the proposed amendment is to amend the Virginia Independence Program by adding the Targeted Jobs Grant Program. This program provides employers with grants of up to \$1,000 per employee when they hire and retain individuals who have been receiving Temporary Assistance to Needy Families.

Statutory Authority: §§ 63.1-25 and 63.1-25.3 of the Code of Virginia

**Contact:** David E. Olds, Employment Services Program Manager, Department of Social Services, 730 E. Broad St., Richmond, VA 23219, telephone (804) 692-2251 or FAX (804) 692-1709.

## DEPARTMENT OF SOCIAL SERVICES

† **July 8, 1998 - 10 a.m.** -- Public Hearing  
Department of Social Services, 730 East Broad Street, 7th Floor, Conference Room, Richmond, Virginia. ♿

A public hearing to receive comments on the proposed plan for implementation of the 1998-99 Energy Assistance Program.

**Contact:** Richard Martin, Regulatory Coordinator, Department of Social Services, 730 E. Broad St., Richmond, VA 23219, telephone (804) 692-1825.

## COMMONWEALTH TRANSPORTATION BOARD

† **July 15, 1998 - 2 p.m.** -- Open Meeting  
Ramada Plaza Resort, 57th and Atlantic Avenue, Virginia Beach, Virginia. ♿ (Interpreter for the deaf provided upon request)

A work session of the board and the Department of Transportation staff.

**Contact:** Shirley J. Ybarra, Secretary of Transportation, 1401 E. Broad St., Richmond, VA 23219, telephone (804) 786-6675.

† **July 16, 1998 - 10 a.m.** -- Open Meeting  
Ramada Plaza Resort, 57th and Atlantic Avenue, Virginia Beach, Virginia. ♿ (Interpreter for the deaf provided upon request)

A monthly meeting of the board to vote on proposals presented regarding bids, permits, additions and deletions to the highway system, and any other matters requiring board approval. Public comments will be received at the outset of the meeting on items on the meeting agenda for which the opportunity for public

---

# Calendar of Events

---

comments has not been afforded the public in another forum. Remarks will be limited to five minutes. Large groups are asked to select one individual to speak for the group. The board reserves the right to amend these conditions. Separate committee meetings may be held on call of the chairman. Contact Department of Transportation Public Affairs at (804) 786-2715 for schedule.

**Contact:** Shirley J. Ybarra, Secretary of Transportation, 1401 E. Broad St., Richmond, VA 23219, telephone (804) 786-6675.

## TREASURY BOARD

**July 15, 1998 - 9 a.m.** -- Open Meeting

**August 19, 1998 - 9 a.m.** -- Open Meeting

James Monroe Building, 101 North 14th Street, Treasury Board Room, 3rd Floor, Richmond, Virginia. 

A regular business meeting.

**Contact:** Gloria J. Hatchel, Administrative Assistant, Department of the Treasury, James Monroe Bldg., 101 N. 14th St., Richmond, VA 23219, telephone (804) 371-6011.

## BOARD FOR THE VISUALLY HANDICAPPED

**July 21, 1998 - 1 p.m.** -- Open Meeting

Department for the Visually Handicapped, Administrative Headquarters, 397 Azalea Avenue, Richmond, Virginia.   
(Interpreter for the deaf provided upon request)

The board is responsible for advising the Governor, the Secretary of Health and Human Resources, the Commissioner, and the General Assembly on the delivery of public services to the blind and the protection of their rights. The board also reviews and comments on policies, budgets and requests for appropriations for the department. At this regular quarterly meeting, the board members will receive information regarding department activities and operations, review expenditures from the board's institutional fund, and discuss other issues raised by board members.

**Contact:** Katherine C. Proffitt, Executive Secretary Senior, Department for the Visually Handicapped, 397 Azalea Ave., Richmond, VA 23227, telephone (804) 371-3140, toll-free 1-800-622-2155, or (804) 371-3140/TDD 

## VIRGINIA WASTE MANAGEMENT BOARD

NOTE: EXTENSION OF COMMENT PERIOD

**June 22, 1998** - Public comments may be submitted until this date.

Notice is hereby given in accordance with § 9-6.14:7.1 of the Code of Virginia that the Virginia Waste Management Board intends to amend regulations entitled: **9 VAC 20-80-10 et seq. Solid Waste**

**Management Regulations.** Proposed Amendment 2 consists of 513 changes developed as a result of the regulatory review process and in response to a petition for rulemaking. The major changes are proposed in the ground water monitoring program, permit-by-rule for captive industrial landfills, addition of presumptive remedies in corrective action and changes in analytical requirements for contaminated soils.

Statutory Authority: § 10.1-1402 of the Code of Virginia.

**Contact:** Wladimir Gulevich, Assistant Division Director, Department of Environmental Quality, P.O. Box 10009, Richmond, VA 23240, telephone (804) 698-4218, FAX (804) 698-4266, toll-free 1-800-592-5482 or (804) 698-4021/TDD



## STATE WATER CONTROL BOARD

**June 26, 1998** - Public comments may be submitted until this date.

Notice is hereby given in accordance with § 9-6.14:7.1 of the Code of Virginia that the State Water Control Board intends to amend regulations entitled: **9 VAC 25-590-10 et seq. Petroleum Underground Storage Tank Financial Responsibility Requirements.** The proposed amendments serve four purposes: (i) to make the regulation conform to amendments in the State Water Control Law (§ 62.1-44.2 et seq. of the Code of Virginia) and to federal financial responsibility requirements; (ii) to permit local government underground storage tank owners to use additional financial responsibility demonstration mechanisms; (iii) to provide liability relief for lenders in accordance with federal and state law; and (iv) to correct typographical errors and omissions.

**Request for Comments:** The purpose of this notice is to provide the public with the opportunity to comment on the proposed amendments and the costs and benefits of the proposal.

**Localities Affected:** There is no locality which will bear any identified disproportionate material water quality impact due to the proposed regulation which would not be experienced by other localities.

**Location of Proposal:** The proposal, an analysis conducted by the department (including a statement of purpose, a statement of estimated impact and benefits of the proposed amendments, an explanation of need for the proposed amendments, an estimate of the impact of the proposed amendments upon small businesses, identification of and comparison with federal requirements, and a discussion of alternative approaches) and any other supporting documents may be examined by the public at the department's Office of Spill Response and Remediation, 629 East Main Street, 7th Floor, Richmond, Virginia, and the department's regional offices (listed below) between 8:30 a.m. and 4:30 p.m. of each business day until the close of the public comment period.

Southwest Regional Office  
Department of Environmental Quality  
355 Deadmore Street  
Abingdon, Virginia  
Phone: (540) 676-4800

West Central Regional Office  
Department of Environmental Quality  
3019 Peters Creek Road  
Roanoke, Virginia  
Phone: (540) 562-6700

Lynchburg Satellite Office  
Department of Environmental Quality  
7705 Timberlake Road  
Lynchburg, Virginia  
Phone: (804) 582-5120

Valley Regional Office  
Department of Environmental Quality  
4411 Early Road  
Harrisonburg, Virginia  
Phone: (540) 574-7800

Fredericksburg Satellite Office  
Department of Environmental Quality  
300 Central Road, Suite B  
Fredericksburg, Virginia  
Phone: (540) 899-4600

Piedmont Regional Office  
Department of Environmental Quality  
4949-A Cox Road  
Glen Allen, Virginia  
Phone: (804) 527-5020

Tidewater Regional Office  
Department of Environmental Quality  
5636 Southern Boulevard  
Virginia Beach, Virginia  
Phone: (757) 518-2000

Northern Regional Office  
Department of Environmental Quality  
13901 Crown Court  
Woodbridge, Virginia  
Phone: (703) 583-3800  
Statutory Authority: §§ 62.1-44.34:9 and 62.1-44.34:12 of  
the Code of Virginia.

Public comments may be submitted until 4:30 p.m. June 26,  
1998.

**Contact:** Mary-Ellen Kendall, Financial Programs Manager,  
Office of Spill Response and Remediation, Department of  
Environmental Quality, P. O. Box 10009, Richmond, VA  
23240-0009, telephone (804) 698-4298, FAX (804) 698-  
4266, toll-free 1-800-592-5482 or (804) 698-4021/TDD ☎

## INDEPENDENT

### STATE LOTTERY BOARD

**June 24, 1998 - 9:30 a.m.** -- Open Meeting  
State Lottery Department, 900 East Main Street, Richmond,  
Virginia. ♿ (Interpreter for the deaf provided upon request)

A regular business meeting of the board. Public  
comment will be received at the beginning of the  
meeting.

**Contact:** David L. Norton, Esq., Director, Legislative and  
Regulatory Affairs, State Lottery Department, 900 E. Main  
St., Richmond, VA 23219, telephone (804) 692-7109 or FAX  
(804) 692-7775.

## LEGISLATIVE

### VIRGINIA CODE COMMISSION

**July 8, 1998 - 10 a.m.** -- Open Meeting  
**September 16, 1998 - 10 a.m.** -- Open Meeting  
General Assembly Building, 910 Capitol Street, Speaker's  
Conference Room, 6th Floor, Richmond, Virginia. ♿  
(Interpreter for the deaf provided upon request)

A meeting to continue with the recodification of Titles 2.1  
and 9 of the Code of Virginia.

**Contact:** Jane Chaffin, Deputy Registrar, General Assembly  
Bldg., 910 Capitol Street, 2nd Floor, Richmond, VA 23219,  
telephone (804) 786-3591, FAX (804) 692-0625 or e-mail  
jchaffin@leg.state.va.us.

### COMMISSION ON COORDINATION OF SERVICES TO FACILITATE SELF-SUFFICIENCY AND SUPPORT OF PERSONS WITH PHYSICAL AND SENSORY DISABILITIES (HJR 274)

**July 22, 1998 - 9 a.m.** -- Open Meeting  
**September 15, 1998 - 9 a.m.** -- Open Meeting  
General Assembly Building, 910 Capitol Square, House  
Room D, Richmond, Virginia. ♿ (Interpreter for the deaf  
provided upon request)

A regular meeting. Questions regarding the meeting  
should be addressed to Brian Parsons or Barbara Ettner  
at the Virginia Board for People with Disabilities, (804)  
786-0016. Individuals requiring interpreter services or  
other special assistance should contact the Committee  
Operations Office at least 10 working days prior to the  
meeting.

**Contact:** Barbara Regen, House Committee Operations,  
P.O. Box 406, Richmond, VA 23218, telephone (804) 698-  
1540 or (804) 786-2369/TDD ☎

---

# Calendar of Events

---

## **JOINT SUBCOMMITTEE STUDYING POTENTIAL CHANGES IN RESTRUCTURING THE ELECTRICAL UTILITIES INDUSTRY IN THE COMMONWEALTH (SJR 91, 1998)**

† **June 30, 1998 - 9 a.m.** -- Open Meeting  
General Assembly Building, 910 Capitol Square, Senate Room B, Richmond, Virginia.  (Interpreter for the deaf provided upon request)

A meeting of the Task Force on Stranded Costs and Related Issues. Individuals requiring interpreter services or other accommodations should call or write Thomas C. Gilman seven working days before the meeting.

**Contact:** Thomas C. Gilman, Senate Committee Operations, P.O. Box 396, Richmond, VA 23218, telephone (804) 698-7450 or (804) 698-7419/TDD 

**July 9, 1998 - 10 a.m.** -- Open Meeting

**August 18, 1998 - 10 a.m.** -- Open Meeting  
General Assembly Building, 910 Capitol Square, Senate Room B, Richmond, Virginia.  (Interpreter for the deaf provided upon request)

A regular meeting. Individuals requiring interpreter services or other accommodations should call or write Thomas C. Gilman seven working days before the meeting.

**Contact:** Thomas C. Gilman, Senate Committee Operations, P.O. Box 396, Richmond, VA 23218, telephone (804) 698-7450 or (804) 698-7419/TDD 

## **SPECIAL AGRICULTURE SUBCOMMITTEE STUDYING THE IMPACT OF INDUSTRIAL SWINE PRODUCTION IN VIRGINIA (HJR 573, 1997)**

† **July 15, 1998 - 10 a.m.** -- Open Meeting  
General Assembly Building, 910 Capitol Square, House Room C, Richmond, Virginia. 

A regular subcommittee meeting. Any questions concerning the agenda should be addressed to Nicole Beyer, Staff Attorney, Division of Legislative Services, (804) 786-3591. Individuals requiring interpreter services or other special assistance should contact Committee Operations at least 10 days prior to the meeting.

**Contact:** Kathleen Myers, Committee Operations, House of Delegates, State Capitol, P.O. Box 406, Richmond, VA 23218, telephone (804) 698-1540 or (804) 786-2369/TDD 

## **JOINT LEGISLATIVE AUDIT AND REVIEW COMMISSION**

† **July 13, 1998 - 10 a.m.** -- Open Meeting  
General Assembly Building, 910 Capitol Square, Senate Room A, Richmond, Virginia. 

Staff briefings on the status of ADAPT and on the Department of Health's monitoring of HMO's VRS oversight.

**Contact:** Phillip A. Leone, Director, Joint Legislative Audit and Review Commission, General Assembly Building, 910 Capitol St., Suite 1100, Richmond, VA 23219, telephone (804) 786-1258.

## **CHRONOLOGICAL LIST**

### **OPEN MEETINGS**

#### **June 22**

Historic Preservation Foundation, Virginia Nursing, Board of

#### **June 23**

Independent Living Council, Statewide Nursing, Board of  
Small Business Financing Authority, Virginia  
- Loan Committee

#### **June 24**

Contractors, Board for  
Forestry, Department of  
- Reforestation of Timberlands Board  
Lottery Board, State  
Medicine, Board of  
- Informal Conference Committee  
† Professional Counselors, Marriage and Family Therapists and Substance Abuse Treatment Professionals, Board of Licensed  
Real Estate Board  
- Common Interest Community Management Information Fund Advisory Committee

#### **June 25**

† Audiology and Speech-Language Pathology, Board of Compensation Board  
Hearing Aid Specialists, Board for  
† Professional Counselors, Marriage and Family Therapists and Substance Abuse Treatment Professionals, Board of Licensed  
Real Estate Board  
- Education Committee  
- Fair Housing Committee  
† Richmond Hospital Authority  
- Board of Commissioners  
† Science Museum of Virginia

#### **June 26**

Medicine, Board of  
- Informal Conference Committee

#### **June 29**

Alcoholic Beverage Control Board  
Conservation and Recreation, Department of  
- Board on Conservation and Development of Public Beaches  
Funeral Directors and Embalmers, Board of



Public School Authority, Virginia

## June 30

Conservation and Recreation, Department of  
† Electrical Utilities Industry in the Commonwealth, Joint  
Subcommittee Studying Potential Changes in  
Restructuring the  
Marine Resources Commission  
† Outdoors Foundation, Virginia

## July 1

Funeral Directors and Embalmers, Board of

## July 2

† At-Risk Youth and Their Families, Comprehensive  
Services for  
- State Management Team  
Medicine, Board of  
- Informal Conference Committee

## July 7

Conservation and Recreation, Department of  
Hopewell Industrial Safety Council

## July 8

Code Commission, Virginia  
† Community Colleges, State Board for  
Motor Vehicles, Department of  
- Medical Advisory Board  
Nursing Home Administrators, Board of

## July 9

Agriculture and Consumer Services, Department of  
- Virginia Horse Industry Board  
† Community Colleges, State Board for  
Conservation and Recreation, Department of  
- Falls of the James Scenic River Advisory Board  
Electrical Utilities Industry in the Commonwealth, Joint  
Subcommittee Studying Potential Changes in  
Restructuring the  
† Health, Department of  
- Biosolids Use Information Committee  
- Biosolids Use Regulations Advisory Committee

## July 10

Agriculture and Consumer Services, Department of  
- Virginia Sheep Industry Board  
† Dentistry, Board of

## July 13

† Cosmetology, Board for  
† Legislative Audit and Review Commission, Joint

## July 14

† Auctioneers Board, Virginia  
Corrections, Board of  
- Correctional Services Committee  
† Pharmacy, Board of  
Resources Authority, Virginia

## July 15

Conservation and Recreation, Department of  
Corrections, Board of  
- Administration Committee

† Industrial Swine Production in Virginia, Special  
Agriculture Subcommittee Studying the Impact of  
Racing Commission, Virginia  
† Transportation Board, Commonwealth  
Treasury Board

## July 16

† Transportation Board, Commonwealth

## July 17

Dentistry, Board of

## July 20

Accountancy, Board for  
General Services, Department of  
- Design-Build/Construction Management Review  
Board  
Local Government, Commission on

## July 21

Accountancy, Board for  
† Agriculture and Consumer Services, Board of  
† Agriculture and Consumer Services, Department of  
- Virginia Winegrowers Advisory Board  
Environmental Quality, Department of  
- Virginia Ground Water Protection Steering  
Committee  
† Real Estate Appraiser Board  
Visually Handicapped, Board for the

## July 22

Disabilities, Commission on Coordination of Services to  
Facilitate Self-Sufficiency and Support of Persons with  
Physical and Sensory

## July 23

Neurotrauma Initiative Advisory Board, Commonwealth

## July 24

Dentistry, Board of  
† Medicine, Board of  
- Informal Conference Committee

## July 27

† Branch Pilots, Board for

## July 28

Agriculture and Consumer Services, Department of  
- Virginia Small Grains Board  
Manufactured Housing Board, Virginia  
† Marine Resources Commission

## July 29

Disability Services Council

## July 30

† Branch Pilots, Board for

## August 5

† Labor and Industry, Department of  
- Apprenticeship Council

## August 6

Agriculture and Consumer Services, Department of  
- Virginia Soybean Board

---

# Calendar of Events

---

Medicine, Board of  
- Informal Conference Committee

**July 8**  
† Social Services, Department of

**August 11**  
Corrections, Board of  
- Correctional Services Committee  
Land Evaluation Advisory Council, State

**August 12**  
Corrections, Board of  
- Administration Committee  
† Funeral Directors and Embalmers, Board of

**August 17**  
General Services, Department of  
- Design-Build/Construction Management Review  
Board

**August 18**  
Electrical Utilities Industry in the Commonwealth, Joint  
Subcommittee Studying Potential Changes in  
Restructuring the

**August 19**  
Treasury Board

**August 20**  
Conservation and Recreation, Department of  
Retirement System, Virginia

**August 25**  
Asbestos and Lead, Virginia Board for  
† Marine Resources Commission

**August 29**  
† Military Institute, Virginia  
- Board of Visitors

**September 3**  
† Medicine, Board of  
- Informal Conference Committee

**September 10**  
Retirement System, Virginia  
- Investment Advisory Committee

**September 15**  
Disabilities, Commission on Coordination of Services to  
Facilitate Self-Sufficiency and Support of Persons with  
Physical and Sensory

**September 16**  
Code Commission, Virginia

**September 22**  
† Marine Resources Commission

## PUBLIC HEARINGS

**June 23**  
Motor Vehicle Dealer Board

**June 29**  
† Game and Inland Fisheries, Department of